

The Radio Dealer

For the Radio Retailer



Published Monthly
by The Radio Dealer,
1133 Broadway, New
York, N. Y.

VOL. I NO. 4

Application pending for
entry as second class
matter at the Post Office
at New York, N. Y.

ONE DOLLAR THE YEAR

JULY 1922



Profit by the success of Magnavox Radio

FOR every radio supply dealer, the success of Magnavox Radio, the Reproducer Supreme, brings a real opportunity which calls for immediate action.

As extensively advertised in newspapers and national magazines—(the Saturday Evening Post, Literary Digest, American Magazine, Popular Science Monthly and others of technical and general interest) the Magnavox products are:—

R-2—Magnavox Radio with 18-inch horn, for those who wish the utmost in amplifying power: for large audiences, dance halls, etc.

R-3—Magnavox Radio with 14-inch horn, ideal for homes, amateur stations, offices, etc.

Model C—Magnavox Power Amplifier insures largest possible power input for Magnavox Radio.

Write us for full information about Magnavox Radio and how we help you sell it.

THE MAGNAVOX COMPANY

Home Office and Factory:
Oakland, Calif.

New York: 370 Seventh Ave.

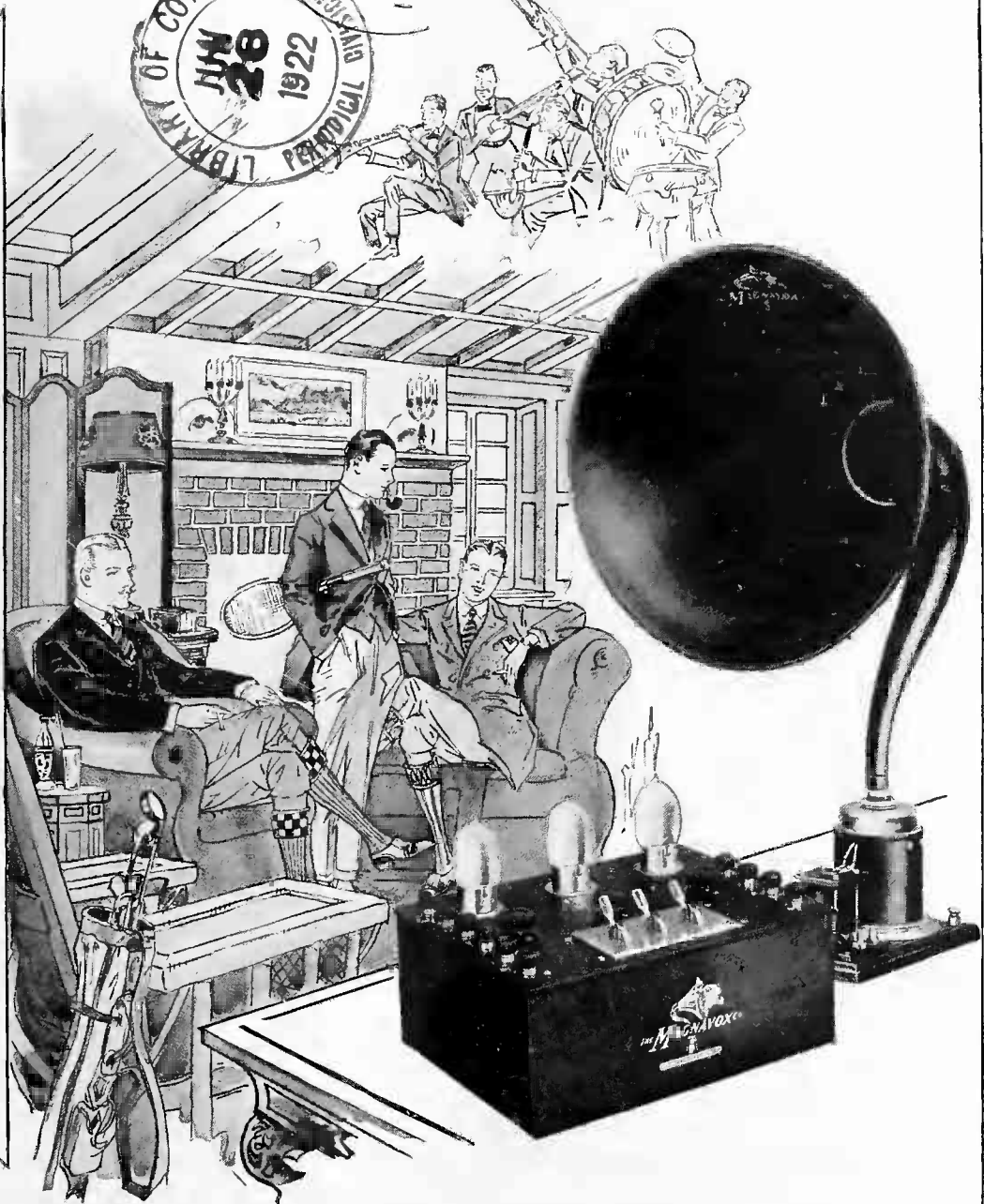

MAGNAVOX Radio

The Reproducer Supreme

An Essential Part of Every Receiving Set

"Black Beauty" Dial and Knob

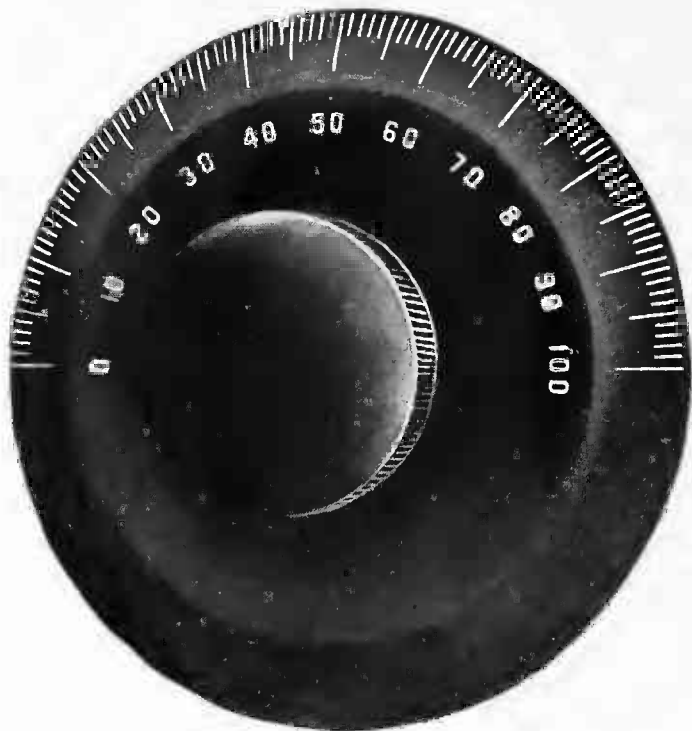

Our No. 1373—Made in 2", 3", 3 1/4", 3 5/8", 4", with 3/16" or 1/4" shaft. They're all guaranteed not to warp, have a permanent jet black surface with genuine silver plated calibrations and figures engraved thereon. Sold without knobs to manufacturers if necessary.

Mr. Manufacturer:

Get ahead of your competitors by using No. 1373 Dial for enhanced appearance, moderate price and quick deliveries. Write for dealers, jobbers or manufacturers' prices.

ETCHED PRODUCTS CORP.

MFGS. NAME-PLATES, DIALS, SCALES, ETC.

LONG ISLAND CITY, N. Y.

Tel. Hunters Point 6230-6231

Detroit	Milwaukee	Des Moines	Seattle
Newark	Boston	Chicago	Cleveland

A Chain Is As Strong As Its Weakest Link

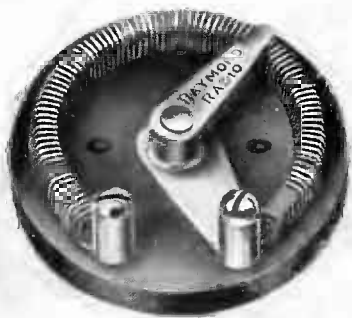

The weakest link in a rheostat is generally the resistance element. The Raymond rheostat has the element mechanically pinned and also held to the base by a special composition glue. The rheostat has an excellent appearance,



uses no metal parts on front of panel, is smooth running and silent in operation.

Every Raymond Radio product has had each individual part carefully designed and tested.

RAYMOND RADIO CORPORATION

Manufacturers to the Radio Industries

Executive Offices: 309 LAFAYETTE STREET, NEW YORK CITY
Works: FARMINGDALE, LONG ISLAND



R-E Vacuum Tube Socket

Type SA—Style No. 166

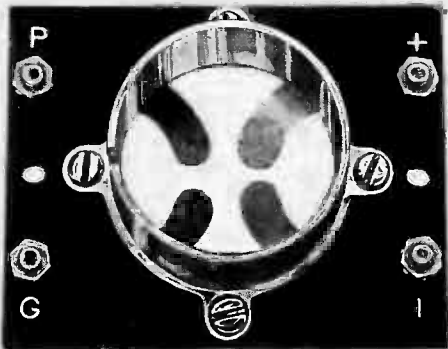

List Price \$1.00

THE Type SA Vacuum Tube Socket represents the most efficient tube receptacle ever produced. Combining all the qualities of a high grade tube socket, it features extremely low capacity losses and a minimum of energy leakage.

Mechanically, this receptacle is designed to meet the most exacting requirements. The shell, made from high-grade sheet brass, is securely mounted on a heat-proof composition base $2\frac{1}{4}'' \times 2\frac{7}{8}'' \times \frac{3}{8}''$ thick. The contact springs are of Phosphor Bronze, and are mounted in such a way as to eliminate all possible chance of accidental short-circuit.

The construction of the socket permits back-mounting by simply reversing the contact screws. If desired, the shell may be removed and mounted separately on a panel. All metal parts have a highly polished nickel finish, making the socket a most attractive unit.

R-E Inductance Switch

Type SC—Style No. 167

THE Type SC inductance switch, pictured here, is the very best, and most correctly designed inductance switch on the Radio market. It is rugged in construction, and is easy to mount. A metal lug is provided, to insure positive electrical connections. The tapered knob fits the fingers easily, and the price is within the reach of all.

The bushing is designed to fit a $\frac{5}{16}''$ hole. The switch arm is made of laminated spring phosphor bronze, and has a radius of $1\frac{3}{8}''$. All metal parts are nickle plated, and the switch arm is given a highly polished finish.



List Price \$0.50

SPECIAL NOTICE

WE are prepared to meet your demands for any type of radio equipment on the market. We are producing a new bulletin—"Bulletin RE4"—which will list a representative line of high grade Radio Equipment. A copy will be mailed to you at your request. Write today.

THE RADIO ELECTRIC CO.
Manufacturers and Jobbers in
RADIO EQUIPMENT
 1427-29 LIBERTY AVENUE
PITTSBURGH, PA.

MOTOR GENERATOR SETS FOR CHARGING STORAGE BATTERIES

OPERATING ELECTRO MAGNETS, BELLS OR ANY FORM OF SIGNALS

MOTOR END

32 VOLTS, D.C.
85 VOLTS, D.C.
110 VOLTS, D.C.
220 VOLTS, D.C.

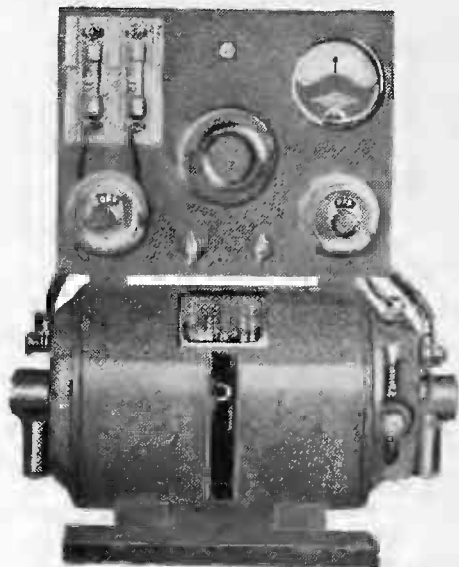

GENERATOR END

8 TO 10 VOLTS
8 TO 16 VOLTS
24 TO 30 VOLTS
500 VOLTS

ALL TYPES OF MOTORS IN STOCK

110 Volts, A.C., 25 to 133 Cycles

220 Volts, A.C., 25 to 133 Cycles

PREMIER EMERGENCY CORP.

767 THIRD AVENUE

VANDERBILT 7500

NEW YORK CITY

BOUGHT, SOLD AND REPAIRED

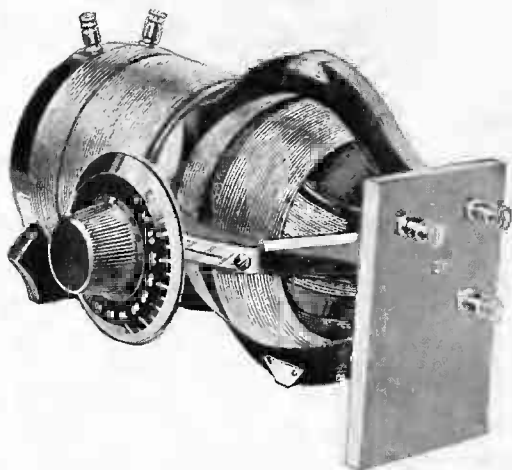

VARIO COUPLER
TYPE C

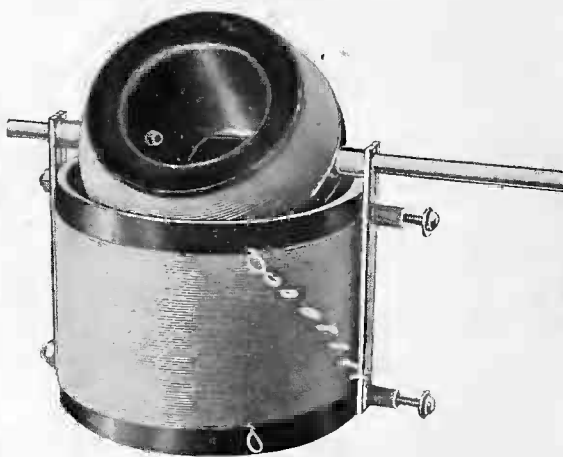

VARIOMETER
TYPE AI

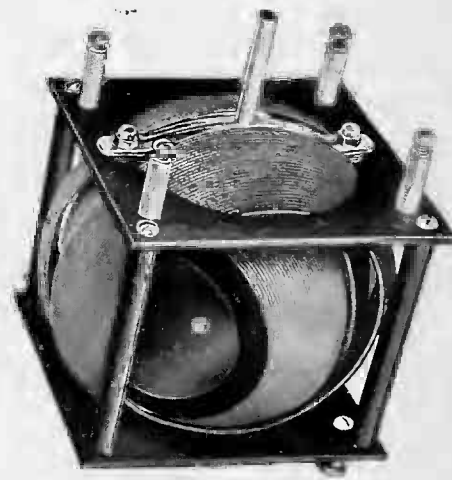

SHORT WAVE UNIT
TYPE E

Also Making

"A Real Slider for Real Radio Fans"

Dealers and Jobbers write for proposition

NELSON RADIO PARTS CO.

89 ACADEMY ST.,

NEWARK, N. J.

\$5.

\$5.

A MARVEL OF SIMPLICITY AND PERFECTION

The Shell Shape Does It!

THE ONLY amplifier built on the correct sound-projecting principle and according to laws of acoustics. No tubes to muffle the sound—no horn to distort and destroy delicate notes.

Substantially made of heavy aluminum—beautifully designed—highly polished. Portable. Only 8½" high. Use your own standard receivers. Better than the Best.

Lowest in Price **\$5.00**

Special Proposition to Dealers and Distributors



PATENT PENDING

SHELSTONE LOUD SPEAKER

SHELSTONE RADIO SALES CO.
20 Clinton St. Newark, N. J.

\$5.

\$5.

Condenser
No. 3

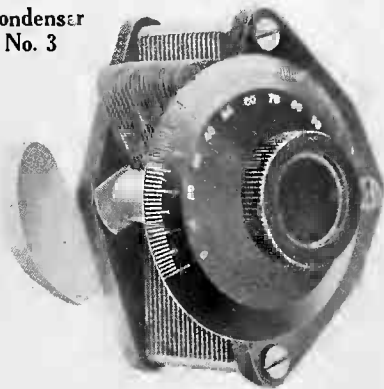

CHELSEA

Variable Condensers
(Die-Cast Type)

- No. 1.—.0011 m. f. mounted \$5.00
- No. 2.—.0006 m. f. mounted 4.50
- No. 3.—.0011 m. f. unmounted 4.75
- No. 3.—.0011 m. f. unmounted, without dial... 4.35
- No. 4.—.0006 m. f. unmounted 4.25
- No. 4.—.0006 m. f. unmounted, without dial... 3.85

Top, bottom and knob are genuine bakelite, shaft of steel running in bronze bearings, adjustable tension on movable plates, large bakelite dial reading in hundredths, high capacity, amply separated and accurately spaced plates.

Unmounted types will fit any panel and are equipped with counterweight.

Purchase from your dealer; if he does not carry it, send to us.



The Chelsea Amplifying Transformer is a supreme attainment in the design of Audio Frequency Transformers. It embodies the highest grade of materials obtainable and proper design, which reflects the result attained namely high amplification factor. It is unequalled either in electrical characteristics or good appearance.

Purchase from your dealer.

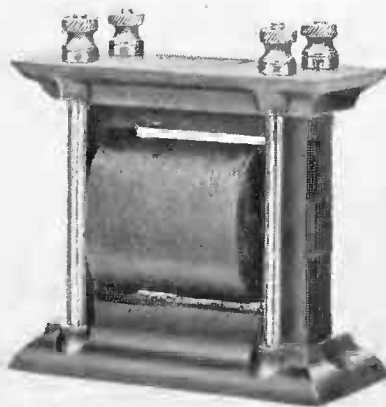

NO. 50. PRICE AS SHOWN, \$4.50

"Chelsea Bakelite Socket No. 60"

This socket has a bakelite base supporting four external, readily accessible binding posts. The tube receptacle is highly polished nickel and will take any standard detector and amplifier tube as well as the smaller size power tubes. It is primarily designed for receiving circuits, and may be mounted on either table or panel.

Positive contact springs.

An added beauty to any radio station.

Price as shown, \$1.00

Purchase from your dealer.

CHELSEA RADIO CO., 150 Fifth Street, Chelsea, Mass.

Manufacturers of Radio Apparatus and Moulders of Bakelite and Condensite

JOBBERS! DEALERS! MANUFACTURERS!

We invite your inquiries on the following:

Telephone Plugs

Fixed Condensers

Knock Down Crystal Detectors

Variable Condensers

Crystal Detectors

Write Us for Prices

THE WOLBRACK CO., Inc. (DEPT. C.)

Largest Manufacturers—Distributors of Radio Equipment

1778 Broadway, New York

"From a Contact to a Complete Set"

SELECTOR

A selective radio contact switch. For varying the number of turns in any kind of radio tuning coil.

The SELECTOR can be mounted on coupler or coil direct, thus reducing leads to a minimum. Short leads and positive contact in radio instrument wiring are not only necessary, but are imperative for highest efficiency.

The SELECTOR combines these essential features and in addition is compact, positive and will give that commercial appearance to your panel.

Price \$4.25 Postpaid

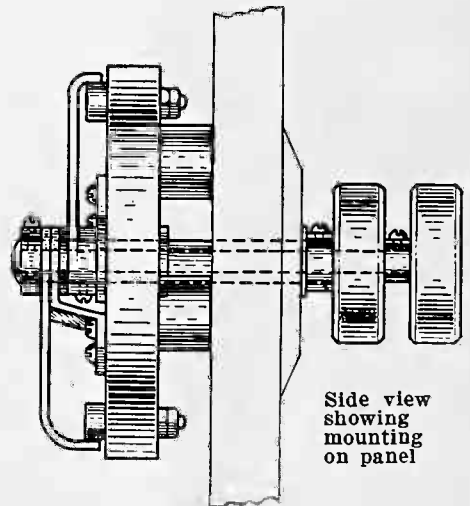
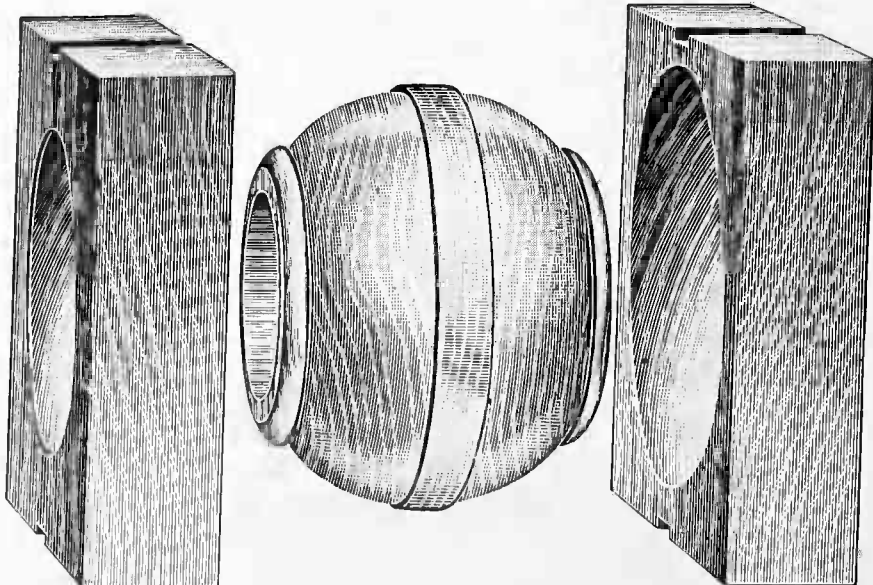

Side view showing mounting on panel

ROTORS AND STATOR SECTIONS

Carefully and accurately made from specially selected and treated woods. Not "mere wood turnings," but manufactured to pattern makers standard.

Rotors packed 50 and 100 in package. Stator sections packed 100 and 200 in package.

Dealers! Send for interesting circular and attractive proposition.

Norris Electrical Specialties Co., Inc.

126 Liberty Street, New York

TELEPHONE RECTOR 6669



NATIONAL

Seamless Tubing in Large Diameters

For Vario-couplers, Variometers, Tuning Coils and wherever you use large diameter fibre tubing, National Seamless Tubing is less expensive and infinitely superior.

National Seamless Tubing is a specially developed, laminated tubing that retains its form and will not warp, swell or shrink. Exact in both diameters and easily worked.

Can be furnished in dark gray fibre, black fibre or dipped in insulating varnish. Any quantities, diameters from 3" to 4 1/2" L. D. Any wall from 3/32" up.

Give us your specifications. We'll send samples and prices.

National Fibre for Panels

Hard Black Panel Stock of Good Dielectric strength. Gives satisfaction for Condenser tops and bottoms, rheostat bases, washers, bushings, etc. Let us quote on the stock itself, or on completed parts machined to order.

Peerless Insulation

The standard thin weight fibre insulation or "fish paper."

NATIONAL FIBRE & INSULATION CO.
Box 450 YORKLYN · DELAWARE

NEW YORK CHICAGO PHILADELPHIA DETROIT	SAN FRANCISCO CLEVELAND	OMAHA PITTSBURGH	BOSTON ROCHESTER	BIRMINGHAM ST. LOUIS	SALT LAKE CITY BALTIMORE HAVANA, CUBA LONDON, ENGLAND
--	----------------------------	---------------------	---------------------	-------------------------	--

In CANADA: National Fibre Co. of Canada, Ltd. TORONTO

Let Our Free Service Bureau Help You Supply Your Needs

Tell us your needs and we'll put you in touch with reputable firms to the end that you will receive information on the latest and best equipment. A post card will do or use the coupon below.

- A**
- 1 "A" Batteries
- 2 Aerials
- 3 Aerial wire
- 4 Aerial protectors
- 5 Aerial switches
- 6 Aerial insulators
- 7 Aerial loop
- 8 Air condensers
- 9 Adapters
- 10 Amplifiers
- 11 Amplifying units
- 12 Aluminum wire
- 13 Ammeters
- 14 Amplifying tubes
- 15 Amplifying horn
- 16 Amplifying transformers
- 17 Antennae, cage
- 18 Audio frequency transformers
- 19 Automatic transmitters
- B**
- 21 "B" Batteries
- 22 Batteries, "A"
- 23 Batteries, dry
- 24 Batteries, storage
- 25 Battery chemicals
- 26 Battery chargers
- 27 Battery testing instruments
- 28 Battery switches
- 29 Battery rheostats
- 30 Battery clips
- 31 Battery handles
- 32 Battery potentiometer
- 33 Binding posts
- 34 Books
- 35 Brass parts
- 36 Bushings
- 37 Bulbs
- 38 Buzzers
- C**
- 41 Cabinets
- 42 Cam switches
- 43 Carbon potentiometer
- 44 Change-over switch
- 45 Charging rectifier
- 46 Choke coil
- 47 Cat whiskers
- 48 Cap nuts
- 49 Carbon walls
- 50 Cardboard tubes
- 51 Chopper, rotary
- 52 Clips
- 53 Clips
- 54 Coils
- 55 Coil mountings
- 56 Coil plugs
- 57 Coils, spark
- 58 Condensers
- 59 Condensers, fixed
- 60 Condensers, variable
- 61 Condensers, air
- 62 Condensers, mica
- 63 Condensers, loading
- 64 Connection blocks
- 65 Control panels
- 66 Condenser parts
- 67 Copper wire
- 68 Cords
- 69 Cord tips
- 70 Crystals
- 71 Crystal detector units
- 72 Crystal receiving sets
- 73 C. W. Transmitter sets
- 74 C. W. Filament heated transformers
- 75 C. W. Inductances
- 76 C. W. Power transformers
- D**
- 81 Detectors
- 82 Detector panels
- 83 Detector tubes
- 84 Detector minerals
- 85 Detector units
- 86 Dictionary, Radio
- 87 Dials
- 88 Dry batteries
- 89 Drawings
- 90 Diagrams
- E**
- 91 End mountings (tubes)
- 92 Engraving
- F**
- 96 Fan switches
- 97 Filter reactors
- 98 Fixed condensers
- 99 Fire extinguishers
- 100 Filament rheostat
- 101 Filter coils
- 102 Flashlights
- 103 Fuse terminals
- G**
- 106 Gaps, Spark
- 107 Generators
- 108 Grid condensers
- 109 Grid leaks
- 110 Grid leaks, variable
- 111 Grid coils
- 112 Ground clamps
- 113 Ground wires
- 114 Ground switches
- H**
- 116 Headsets and bands
- 117 Honeycomb coils
- 118 Honeycomb mountings
- 119 Honeycomb plugs
- 120 Hook switches
- 121 Horns
- 122 Hydrometers
- I**
- 126 Indicators
- 127 Inductances, C. W.
- 128 Insulators
- 129 Insulation
- 130 Invention developments
- 131 Jacks
- J**
- L**
- 136 Lead-in wire
- 137 Lead-in switches
- 138 Lead-in bushings
- 139 Lead-in insulators
- 140 Levers, Switch
- 141 Lightning arrestors
- 142 Lightning switches
- 143 Loading coils
- 144 Loading inductance
- 145 Loose couplers
- 146 Loud speakers
- 147 Locked lever switches
- 148 Lock nuts
- 149 Loop aerials
- 150 Lugs
- M**
- 151 Magnetic modulator
- 152 Modulation transformer
- 153 Machine screws
- 154 Magnet wire
- 155 Magazines, Radio
- 156 Mica
- 157 Mica diaphragms
- 158 Mica condensers
- 159 Mica diaphragm transformers
- 160 Microphone transformers
- 161 Milliammeters
- 162 Milli-voltmeters
- 163 Motors
- 164 Motor generators
- 165 Mounting coils
- 166 Minerals
- 167 Mountings
- N**
- 171 Name plates
- 172 Nickel parts
- 173 Nuts
- O**
- 176 One stage amplifier units
- 177 Oscillation transformers
- P**
- 178 Panels
- 179 Panel plugs
- 180 Panel controls
- 181 Paper tubes
- 311 Patent registration
- 182 Patent wire
- 183 Patent wire terminals
- 184 Plans
- 185 Phonograph attachments
- 186 Plate condensers
- 187 Porcelain
- 188 Porcelain cleats
- 189 Porcelain insulators
- 190 Porcelain mountings
- 191 Porcelain tubes
- 192 Porcelain V. T. receptacles
- 193 Porcelain V. T. sockets
- 195 Polarity indicators
- 196 Plate connectors
- 197 Paste solder
- 198 Phosphor-bronze wire sheets
- Q**
- 307 Quenching spark gaps
- R**
- 308 Radio books
- 309 Radio schools
- 310 Radio publications
- 199 Radio frequency transformers
- 200 Reactor, plate circuit
- 201 Reactor, filter
- 202 Receiving sets
- 203 Receiving head sets
- 204 Receiving transformers
- 205 Receptors
- 206 Receiver magnets
- 207 Rectifiers
- 208 Rectifying tubes
- 209 Regenerative sets
- 210 Rheostats
- 211 Rheostat wire
- 212 Rods
- 213 Rotary lever switches
- 214 Rotary spark gaps
- 215 Rotary variable condensers
- 216 Rubber parts
- 217 Rotors
- 221 Safety switches
- 222 Safety fuses
- 223 Sliders and rods
- 224 Sockets
- 225 Soft metal
- 226 Shielded dials
- 227 Short wave sets
- 228 Solder
- 229 Solder, bar
- 312 Soldering irons (electric)
- 230 Spark transformers
- 231 Spark coil selectors
- 232 Spaghetti tubing
- 233 Special apparatus
- 234 Spark gaps
- 235 Spring clips
- 236 Storage batteries
- 237 Sectional receiving sets
- 238 Switches
- 246 Tapes
- 247 Telephone cord
- 248 Telephone plugs
- 249 Telephone receivers
- 250 Telegraph keys
- 251 Telegraph teachers
- 252 Testing instruments
- 253 Testing clips
- 254 Terminals
- 255 Thermometers
- 256 Tools
- 257 Trade marks
- 258 Transformers
- 259 Transmitters
- 260 Transmitting sets
- 261 Towers
- 262 Three coil mounting
- 263 Tin foil
- 264 Tuning coils
- 265 Tubes, amplifier
- 266 Tubes, detector
- 267 Tubing, flexible
- 268 Tube sockets
- 269 Tubes
- 270 Tuner and detector cabinets
- 271 Two stage cabinets
- 272 Two stage amplifier unit
- U**
- 276 Unit type receiving sets
- 277 Unassembled sets
- V**
- 281 Vacuum tubes
- 282 Vacuum tube sockets
- 283 Variable condensers
- 284 Variometers
- 285 Vario couplers
- 286 Variable grid leak
- 287 Vernier adjusters
- 288 Vibrators
- 289 Vocaloids
- 290 Voltmeters
- 291 Vulcanized fibre sheets
- 292 V. T. receiving sets
- 293 Variogrid leak
- 294 V. T. detector units
- 295 V. T. control units
- 296 V. T. receptacle
- W**
- 297 Washers
- 298 Watch case receivers
- 299 Wattmeters
- 300 Wave meters
- 301 Wave tuner
- 302 Wire
- 303 Wire, aerial
- 304 Wire, phosphor bronze
- 305 Wire, copper clad
- 306 Wire, magnet

Note the number of the item you want to buy—then check the corresponding number in the coupon below and mail to us.

TEAR OFF HERE

1	2	3	4	5	6	7	8	9	10	11	12	13	14	15	16	17	18	19	20	21
22	23	24	25	26	27	28	29	30	31	32	33	34	35	36	37	38	39	40	41	42
43	44	45	46	47	48	49	50	51	52	53	54	55	56	57	58	59	60	61	62	63
64	65	66	67	68	69	70	71	72	73	74	75	76	77	78	79	80	81	82	83	84
85	86	87	88	89	90	91	92	93	94	95	96	97	98	99	100	101	102	103	104	105
106	107	108	109	110	111	112	113	114	115	116	117	118	119	120	121	122	123	124	125	126
127	128	129	130	131	132	133	134	135	136	137	138	139	140	141	142	143	144	145	146	147
148	149	150	151	152	153	154	155	156	157	158	159	160	161	162	163	164	165	166	167	168
169	170	171	172	173	174	175	176	177	178	179	180	181	182	183	184	185	186	187	188	189
190	191	192	193	194	195	196	197	198	199	200	201	202	203	204	205	206	207	208	209	210
211	212	213	214	215	216	217	218	219	220	221	222	223	224	225	226	227	228	229	230	231
232	233	234	235	236	237	238	239	240	241	242	243	244	245	246	247	248	249	250	251	252
253	254	255	256	257	258	259	260	261	262	263	264	265	266	267	268	269	270	271	272	273
274	275	276	277	278	279	280	281	282	283	284	285	286	287	288	289	290	291	292	293	294
295	296	297	298	299	300	301	302	303	304	305	306	307	308	309	310	311	312	313	314	315

Service Bureau The Radio Dealer,
1133 Broadway, New York City.

We are interested in buying radio equipment and have circled the numbers on this coupon of the items we are ready to buy now. Please have manufacturers of these lines quote us dealers' prices.

Name.....

Address.....

NOW IN STOCK

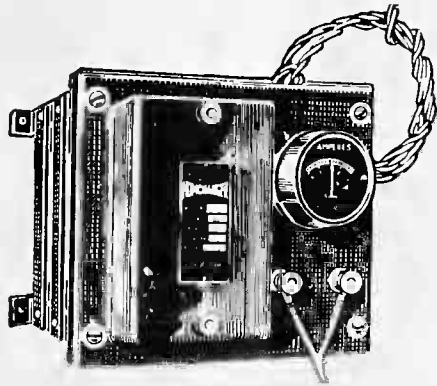

THE HOMCHARGER

connects to any alternating current socket, gives a taper charge—will fully charge any "A" battery overnight. It is self-polarizing. Connect your battery either way and it will always charge. Automatically disconnects battery when power is interrupted. Restarts charging when connections are restored. Adjustable for wave form, frequency and voltage. Contains only one moving and two wearing parts, lasting thousands of hours, replaceable as a unit for \$1.00. The highest charging rate, greatest efficiency, and simplest of any rectifier selling for less than \$100.00. Bulletin 628 proves it. Ask for your copy.

Manufactured in sizes for charging three or six cell batteries from both alternating and direct current circuits. Cannot injure battery—will last a lifetime—approved by underwriters—satisfaction guaranteed.

Announcing

The new panel mounting Dial SWITCH, absolutely the best switch. Just what you have been looking for.

List Price \$1.00

Send \$1.00 for sample.

Money back if it isn't the BEST SWITCH you've ever seen.

Delivery begins July 10th.

PAT. APPL'D. FOR

LOOK FOR THIS LABEL ON RADIO APPARATUS



TESTED AND APPROVED
"THE BEST IN RADIO"
VIRGINIA RADIO CORP.

All Storage Batteries fully CHARGED before being shipped. We distribute RADIO supplies of all leading makes.

VIRGINIA RADIO CORPORATION
MANUFACTURERS—JOBBER
CHARLOTTESVILLE, VA.

IMMEDIATE SHIPMENT



When you are contemplating the purchase of a Radio A battery just think of a battery company that has a reputable name and real backing behind its name. A Radio A battery should have four essentials: good name, ample capacity, good looks and above all good dependability. All the above essentials will readily be found in our Eveready Radio batteries.



25 YEARS

of active, practical experience in the manufacture of hundreds of thousands of phones from raw materials to the finished product of world-wide reputation for excelling all others.

15 YEARS

ago, our chief designer and manufacturing expert made wireless phones for the Government which were pronounced by the best informed, then, as now, Government wireless expert to be far superior to all others he was able to get.

When you "listen in" on Red Star Professional or Long Distance phones you instantly realize that here are the phones you have hoped for.

IN TIME OF PLENTY PREPARE FOR SHORTAGE

Wise dealers will stock up on Red Star Professional and Red Star Long Distance head sets now and clean up big profits this fall, as they will be first choice in the coming mad rush for Radio parts.

SALE AND PROFIT COMPELLING

We have such a campaign all mapped out for dealers that will bring them huge sales and profits NOW as well as in the future. Write us while this splendid opportunity is being broadcasted and thereby amplify your bank account NOW.

Red Star Professional Head Sets, 2400 Ohms, \$8.50
Red Star Long Distance Head Sets, 3200 Ohms, 10.50

THE PEER OF ALL OTHERS—A TEST TELLS

Liberal discounts and get-the-business sale compelling helps for bona fide dealers.

GENERAL RADIO EQUIPMENT MFG. GO.

1143-45 DIVERSEY PARKWAY

CHICAGO, ILL., U. S. A.

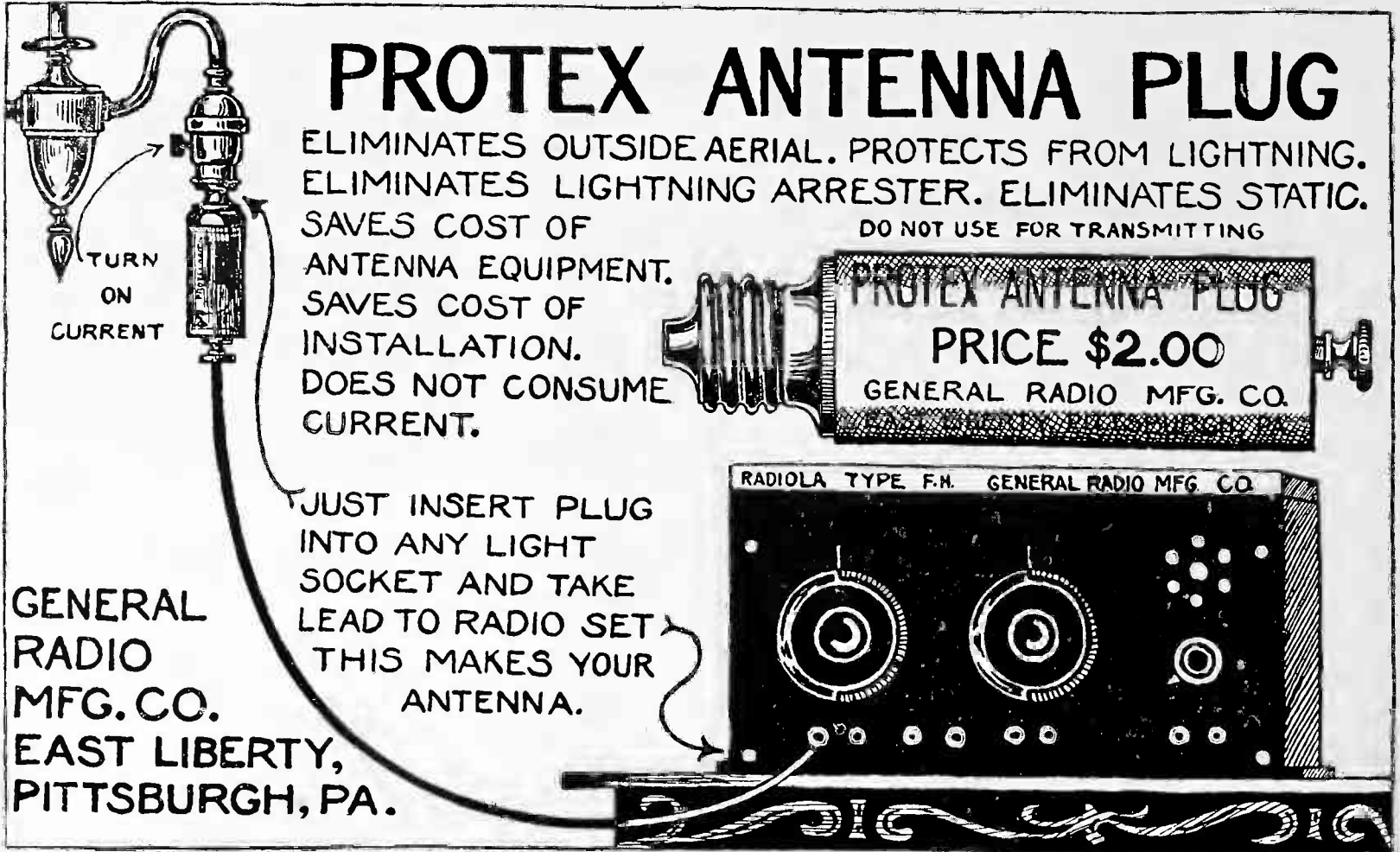

PROTEX ANTENNA PLUG

ELIMINATES OUTSIDE AERIAL. PROTECTS FROM LIGHTNING.
ELIMINATES LIGHTNING ARRESTER. ELIMINATES STATIC.
SAVES COST OF ANTENNA EQUIPMENT.
SAVES COST OF INSTALLATION.
DOES NOT CONSUME CURRENT.

DO NOT USE FOR TRANSMITTING

TURN ON CURRENT

PROTEX ANTENNA PLUG
PRICE \$2.00
GENERAL RADIO MFG. CO.

RADIOLA TYPE F.H. GENERAL RADIO MFG. CO.

JUST INSERT PLUG INTO ANY LIGHT SOCKET AND TAKE LEAD TO RADIO SET THIS MAKES YOUR ANTENNA.

GENERAL RADIO MFG. CO.
EAST LIBERTY,
PITTSBURGH, PA.

Back Again!!

THE RADIO TELEGRAPHER

Established in 1917

Official Organ United Telegraphers' Association
The Only Paper for the Professional Radio Operator
Once Each Month. One Dollar the Year

Advertising Rates Upon Application

Published by

HARRY M. KONWISER

Publisher, The Radio Dealer

1133 Broadway

New York City

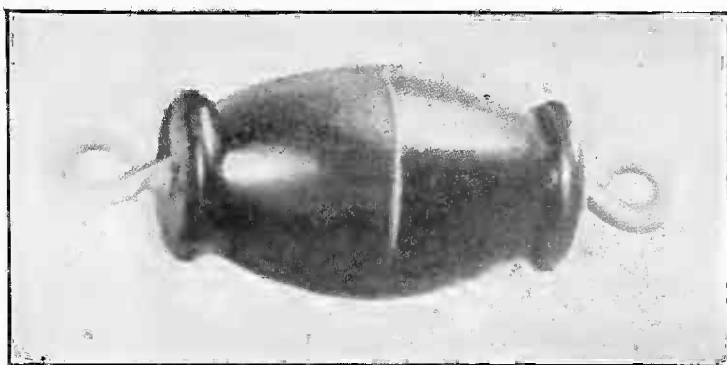
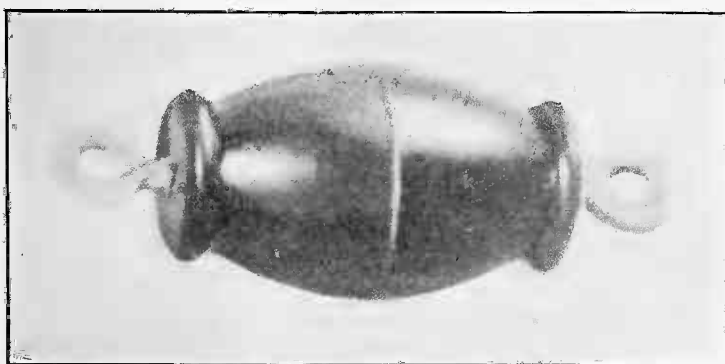

When You Need Insulators

PHONE, WIRE OR WRITE

For Sample and Prices

TERRITORY OPEN TO
RELIABLE JOBBERS

Our Prices are Right

MORSCAN RADIO CO.

196 MARKET STREET

NEWARK, N. J.

Radio Magnavox in stock
For Immediate Delivery

Special:

Switch Levers
\$15.00 per hundred

**DEALERS
JOBBERS**

*Write for
Territory*

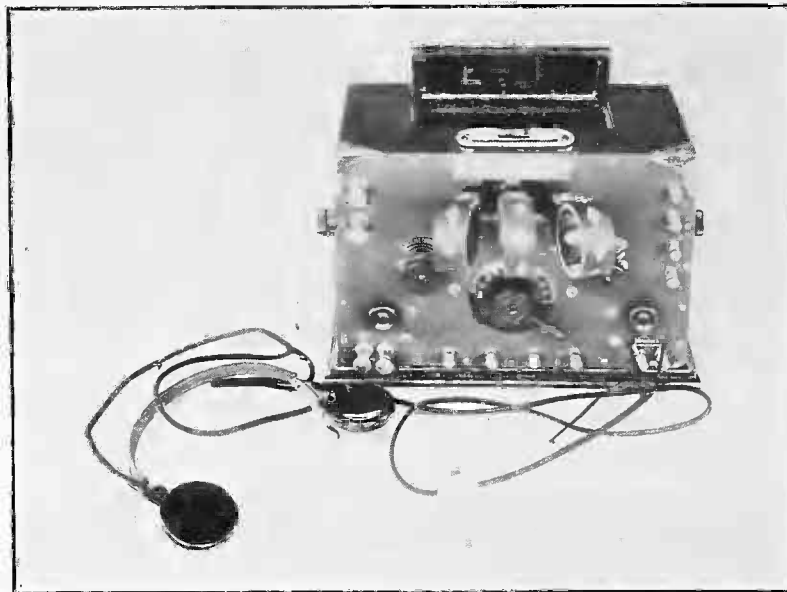

**A Full
Line
of All
Radio
Parts**

Areco Vacuum Tube Set.

American Radio

Phone Watkins 8985

1133 Broadway

**Areco
Telephone
Head Sets**

**Areco
Vario
Couplers**

**Areco
Grid
Leaks**

**Areco
Batteries**

**Areco
Horns**

*All Equipment Bearing "Areco
Address All Communications*



Showing Some of the Areco Line

**All
Equipment
and Parts
Our
Own Make**

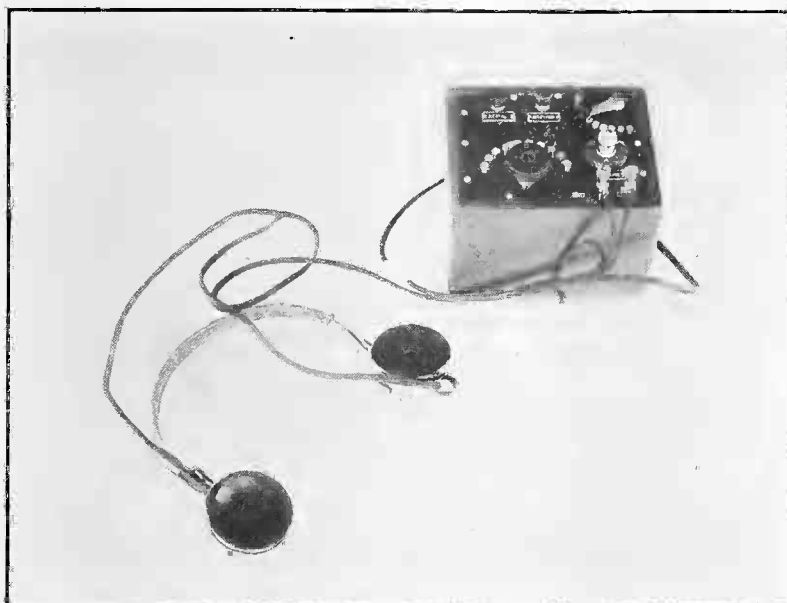

**DEALERS
JOBBERs**

*Write for
Prices*

Areco Crystal Set.

and Electric Co., Inc.

New York City

Factory, Union Hill, N. J.

**Areco
Vario-
meters**

**Areco
Crystal
Sets**

**Areco
Vacuum
Tube Sets**

**Areco
Condensers**

**Areco
Dials**

*Trademark” Positively Guaranteed
to the General Office*



Engineer Milton Stilwell of the Areco Co.

View of “ARECO” Factory

A Real Set in a Carton Retailing at \$7.00

Ready to receive sound waves transmitted 40 to 50 miles; telegraph signals at from 300 to 400 miles. With favorable atmospheric conditions will catch 200 to 600 metre waves.

This is a very efficient and durable instrument, not a cheap toy. The set consists of a crystal type detector, of our own design. The condenser is .005 microfarads, and is of the fixed type. A tested galena crystal is already in place when the set is sold to the customer.

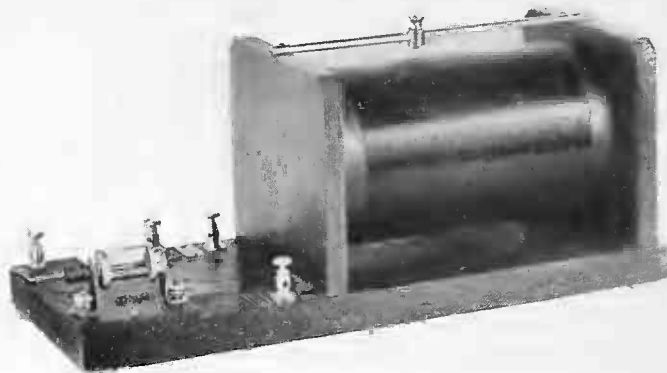

TYPE "ML" RECEIVER SET

The set also includes a brass slider, brass slide rod, tuning coil, end holders, binding posts, binding screws, and a nicely finished hardwood base. List price \$7.00. Packed in carton ready to ship.

We also make a loose coupler set of the Navy type which we call type NT

Write for Particulars

AERIALS

Especially suited for our crystal set are the "WL" aerials. Each aerial set consists of a 100 foot special antennae, hard drawn bare enameled copper, insulators and guy wires. Passes the National Underwriters' Code. Packed in carton ready to ship. List price \$4.00.

DETROIT RADIO COMPANY 1 West 34th Street, New York City

The Montclair Standard

being introduced to dealers has won unsolicited praise for its simplicity of operation and absence of "Tube" noises.

As a simple "Tuner" and Detector Unit it has two features paramount to sales:

First: Aristocratic appearance and excellent workmanship. No expense was spared in producing the unit.

Second: A circuit of radical departure for a non-regenerative design. This instrument has been tested with both the common circuit and the regenerative circuit. Our circuit will bring in the signals louder and clearer on one tube than any 600 metre wave length range instrument we have tested.

The "Montclair" Standard sells for \$35.00.

Special proposition to dealers who do not want to stock heavily during summer months.

Dealers who are having difficulty in securing Standard Apparatus and Complete Sets should write their requirements immediately.

"The best and—only the best"

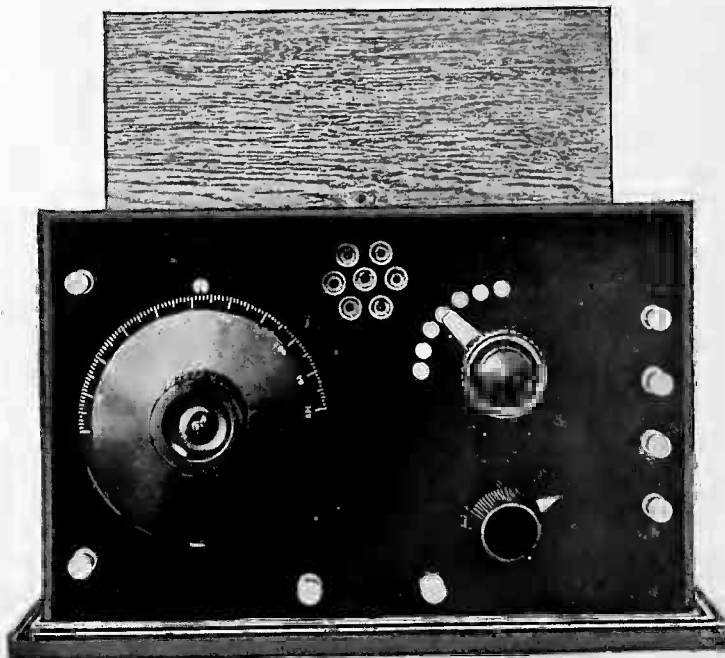

The Montclair Special. List Price \$25

Montclair Radio Manufacturing Corporation

657 Bloomfield Avenue

Montclair, N. J.



THE "DUNCAN"

Stock The "DUNCAN"— It Requires No Aerial

The demand for a radio unit that requires no aerial has been long and insistent. The "Duncan" has been designed to supply this demand and is now available for immediate delivery. It does away with the danger of stringing antenna over power lines, is shock proof and will not damage a receiving set in any way. It operates on A.C. or D.C. electric circuit from 32 to 120 volts.

Be the first in your neighborhood to stock the Duncan and to cash in on the demand that will come from all classes of radio users. It is sure to have instant recognition because the radio world has been waiting for a means of eliminating the dangers and inconveniences of antenna wires.

JOBBER—DEALER—WRITE OR WIRE

Super-Antenna Company

Quincy, Illinois, U. S. A.

Sole Distributors

Live Wire Distributors and Jobbers Wanted For



Model A—List \$150

VECTO

Super Quality Receiving Sets

Conceded to be one of the most elaborate and mechanically perfect sets ever designed. All of our sets are equipped with the VECTO indoor antenna.

Dealers, jobbers and distributors write for our attractive proposition



Model B—List \$170

VICTOR ELECTRICAL TESTING CO.

63 EAST 9th STREET, NEW YORK



“Tested Radio Products of Supreme Merit”

STANDARD RADIO JACKS & PLUGS

CUTS ARE ACTUAL SIZE

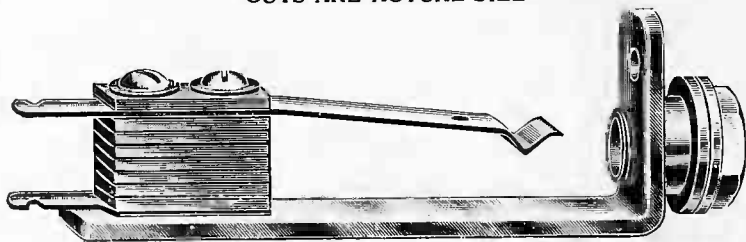

No. B-150 Open Circuit Jack

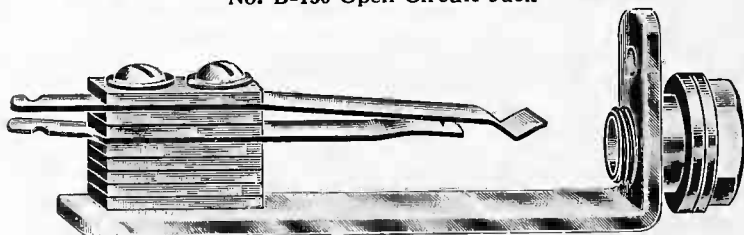

No. B-151 Closed Circuit Jack



No. B-152 Two Circuit Jack

Specially designed for Radio Panel work. Interchangeable with all other standard makes.

So designed and constructed as to be easily mounted on panels of any thickness up to and including $\frac{1}{4}$ ".

The careful design and construction embodies every improvement, thereby furnishing satisfactory performance under varied conditions.

Sturdy construction throughout. Brass frame with adjustable hexagon head bushing fitted with two washers, heavily nickel-plated and polished.

Carefully assembled, adjusted and inspected. Packed in individual containers.

VARIABLE CONDENSERS—Best quality—fully guaranteed. Also Fixed Condensers, Transformers, Dials, Crystal Detectors, Tested Crystals, etc.

DEALERS:—Write for special proposition. You will be interested.

All W. H. B. Products Are Standard
And Fully Guaranteed

WILLIAM H. BASSETT

505 Orange Street, Newark, N. J.

New York Sales Office:

TRIBUNE BUILDING, 154 NASSAU STREET



No. 28 Contact Switch, 1" Radius... Each \$.70
No. 29 Contact Switch, 1 1/4" Radius... \$.70
Packed 50 in a Box



42 37
Pol. Nickel, 1/4 x 1/4 head, 6-32 thread... \$.05
Pol. Nickel, 1/4 x 1/4 head, 4-36 thread... .05
Pol. Nickel, Switch Stop... .05

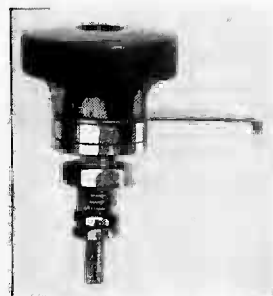

No. 24 Contact Switch, 1 1/4" Radius... Each \$.70
No. 25 Contact Switch, 1 1/2" Radius... .80
Packed 50 in a Box

CHAMPION RADIO JACKS

Nickel Silver Springs
Pure Silver Contacts Perfect Finish



No. 29A Black Composition for 8-32 Screw



No. 1 Open Circuit Jack... Each \$.70



No. 24A Black Composition for No. 6 or No. 8 Screws

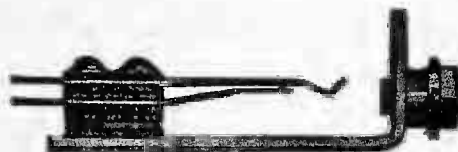

No. 2 Closed Circuit Jack... Each \$.85



No. 10 Black Head Binding Post Nickel Screw and Washer

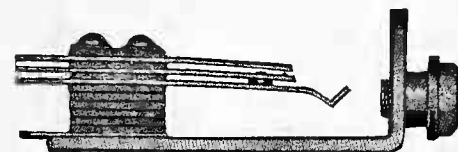

No. 3 Two-Circuit Jack... Each \$1.00



No. 9 Black Head Binding Post, Nickel, Screw and Washer



No. 14 Nickel Binding Post 8-32 Screw

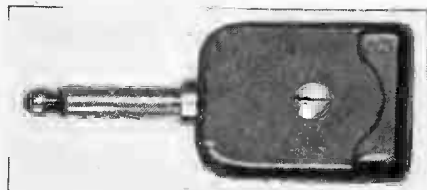

Fits All Jacks
No. 6 Radio Plug... Each \$1.00



No. 32 Condensor... \$.70

MOULDED DIALS AND KNOB

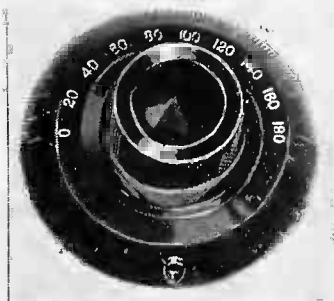

No. 38 Dial, 2 13/16" Dia., 3/16" Shaft... Each \$1.00
No. 39 Dial, 2 13/16" Dia., 1/4" Shaft... 1.00
Packed 12 in a Box

PORCELAIN AERIAL INSULATOR



No. 33 Porcelain Insulator... Each \$.15
Packed 50 in a Box

CHAMPION AERIAL INSULATOR



No. 40 Moulded Insulator

MANUFACTURED BY

Automotive Equipment Co., Inc.

317 Halsey St., Newark, N. J.

CATALOGUE AND PRICES ON REQUEST

IMMEDIATE DELIVERIES



TO THE RADIO PUBLIC
Look for the Placard of the
American Radio Association
 THE NATIONAL ORGANIZATION OF RADIO

BEFORE buying radio apparatus from a dealer—It PROTECTS you!
**REPUTABLE and RESPONSIBLE dealers—interested in the Scientific,
 Commercial and Public PERMANENCY of RADIO:**

DO NOT slash prices or sell below cost in order to take unfair advantage of a competitor; force a small reputable dealer from the field or unload inadequate or inferior equipment on the uninformed radio public.

DO NOT handle the questionable products of unscrupulous and illegitimate manufacturers!

DO NOT misrepresent the possibilities of the products they sell.

DO NOT take advantage of the non-technical radio man, the radio novice or the uninformed radio buying public.

DO NOT let private interests, prejudices, party cliques, politics, affiliations or organizations stand in their way, or prevent them taking a clean, firm, decided policy for the PROTECTION and BENEFIT of the RADIO BUYING PUBLIC by joining the NATIONAL RADIO DEALERS' ASSOCIATION.

THEY—

Do GUARANTEE and BACK UP, with a MONEY BACK GUARANTEE, the products they sell—because they buy from the large or small recognized legitimate manufacturer who knows the REQUIREMENTS of radio and stakes his reputation upon his branded product.

Do believe in an ASSOCIATED SYSTEM and CO-OPERATION between the retailer, jobber and manufacturer for the PERMANENT PROTECTION of the RADIO BUYING PUBLIC which SUPPORTS them.

Do believe in ultimate STANDARD DISCOUNTS, STANDARD SCIENTIFIC QUALITY, STANDARD PRICES and STANDARD POLICIES.

Do believe in WARNING the RADIO BUYING PUBLIC against INFERIOR and INADEQUATE equipment with no GUARANTEE or SCIENTIFIC CONSTRUCTION.

They Do Hold Membership in the
National Radio Dealers Association

The Official National Organization of Radio Dealers

We Urge the Radio Buying Public and Our Many Members to Purchase From Them With the Utmost Confidence!

The National Radio Dealers Association, the commercial division of The American Radio Association, invites all reputable and responsible dealers and manufacturers to membership.

EDWARD, C. TALBOTT, JR., *Executive Secretary*

Executive Offices,

10 N. CLARK ST., CHICAGO

THE RADIO DEALER

The Radio Trade Journal

For The Radio Retailer

CONTENTS JULY, 1922

SPECIAL ARTICLES

Amrad Protects Dealers and Buyers.	26
<i>By H. M. Taylor</i>	
Do You Mistake Noisy B Batteries for Static?	25
<i>By George G. Hyde</i>	
Explaining the Loud Speaker to Crystal Set Customers.	28
<i>By C. M. Hunt</i>	
Fall Business Prospects.	62
<i>By E. M. Jones</i>	
How Patents Protect Your Radio Ideas.	31
<i>By Chauncey P. Carter</i>	
Jersey Review Broadcasts High Class Programs	76
Loop Solves City Aerial Problem.	26
<i>By H. F. Thorbell</i>	
Marconi Announces Progress at Directing Waves.	22
National Radio Exposition Opens at Chicago.	30
Organize Radio Trade Association.	21
Phonolier Equipment Beautiful.	34
<i>By W. J. Whitlawe</i>	
Radio Dealer Starts Trade Mark Bureau.	29
St. Louis Show in the Fall.	28
Standardized Terms for Radio Business.	29
Static—The Radio Alibi.	23
<i>By Perce B. Collison</i>	
The Local Dealer.	39
<i>By J. W. Wellington</i>	
The Fittest Survive.	42
<i>By Thomas J. McElroy</i>	

DEPARTMENTS

What the Manufacturers Are Doing.	56
Advertising for the Retail Dealer.	36
Book Review	70
<i>By B. J. Farrell</i>	
Editorials	32

No Current Necessary With The Racony Plug

The Plug with the (14) Variations

The wonderful new RACONY PLUG now makes it possible to do away entirely with all outside Aerials or clumsy indoor loops. No mechanical skill to install it. Just screw the RACONY PLUG into any electric light socket and run a wire to the Aerial post of the receiving set. There is absolutely no danger of shock or short circuit. No current is used. No necessity for expensive lightning arresters, outside insulators and heavy ground wire. No more hours of labor on the roof or disputes with landlords or fire underwriters.

GET A RACONY PLUG

And Let the Electric Light Wires Act as Your Aerial

You will hear the music perfectly with the RACONY PLUG. The results are as good and in many cases better than those obtainable with outside wires. And you do not have the wind and thunder storms to worry about. No repairs and no expense. The RACONY is good for a lifetime. Nothing to wear out and nothing to renew. In cases where the RACONY PLUG was used in conjunction with an existing outside aerial it has more than doubled the signal strength.

Where an aerial is already erected use a Racony Plug in conjunction and it will double the signal strength.



Patent Applied For

Immediate Deliveries from Stock

Retail Price **\$3.00**

Sold on a "Money Back" guarantee

Manufactured by

RADIO COMPANY of NEW YORK

799 Broadway

New York City

A. BAILLE HUTTON, 23 West 32nd St., New York, distributors for New York City and New Jersey.

FREGOLD CO., 1270 Broadway, New York, distributors for New England States.

GASTON & CO., 165 Broadway, New York, distributors for N. Y. State, (New York City excepted) Dist. of Columbia, Illinois, Ohio, Michigan, Delaware, Missouri, California, Nebraska and Export.

IMPORTANT! The RACONY PLUG

is equipped with four binding posts permitting fourteen adjustments to fit the various capacities of wires of different lengths. A little experimenting will give just the right combination for your wire. Nonvariable plugs, (those having but one outlet), will, in 99 cases out of a 100, not work on your particular length of wire.

From N. Y. Eve. Globe, June 14, 1922.—Plugs are made that are adjustable so that a number of capacities may be tried in order to find the capacity most suitable, in fact, it is not wise to purchase a plug that can not be adjusted.

DISTRIBUTERS WANTED

We have an attractive proposition for livewire distributors. Several territories are still open.

Men with large organizations possessing vision enough to see the tremendous possibilities of the RACONY PLUG as well as the added impetus it will give the Radio Industry as a whole, are invited to call.

The Radio Dealer

THE RADIO TRADE JOURNAL

Edited and Published at

1133 Broadway, New York, N. Y.

FOR THE RADIO RETAILER

VOL. 1. NO. 4

JULY, 1922

ONE DOLLAR THE YEAR

Organize Radio Trade Association

Membership Applications Now Being Accepted for National Organization of Radio Business Men

Every business man in the radio industry is invited to send in his application for membership in "THE RADIO TRADE ASSOCIATION."

This organization will be formed along the lines outlined in this publication last month with separate sections for the various divisions of membership.

Every business man in the radio industry is eligible to membership. Retailers, Jobbers, Manufacturers, THE RADIO TRADE ASSOCIATION will not be exclusive in membership, nor will its efforts be devoted towards forwarding the interests of any particular class or section of the industry.

Several hundred business men, readers of THE RADIO DEALER, have written us last month, as requested in our feature article, urging that the organization of this association be pushed along. A convention will be called at an early date and a permanent organization effected.

Until such a time as the members of this association are able to get together to settle their problems in regard to officers, etc., THE RADIO DEALER will act as organizing headquarters, handling the preliminary detail work. This is our contribution to the trade.

In the next issue of THE RADIO DEALER will appear a list of early members in this association. No schedule of dues has been settled as yet, and memberships may be considered as non dues paying until such time as a vote, either at a convention or by mail, can be taken on the matter. Several firms in the trade have offered to aid the publishers of THE RADIO DEALER in defraying the preliminary organization expenses. While contributions are not solicited, they will be received and recorded.

Radio men are urged to use the coupon appearing on page 87 of this issue.

An outline of the work that this association will do follows:

(1) Organization: National in character. Membership composed of retailers, jobbers and manufacturers.

Sectional organizations, affiliated with the national organization, forming divisions for the various cities where sufficient members wish to meet together regularly for discussion of business problems.

Jobbers Section that would meet with the association at its national meetings, holding one or two special private meetings where problems of the jobber would be discussed.

Manufacturers Section that would meet with the association at its national meetings, holding one or two special private meetings where problems of the manufacturer would be discussed.

(2) Regulation: Supervision of shows, co-operation with amateur bodies in movements for the betterment of the science of radio. A technical service to give the mark of quality and endorsement of the association's laboratory to products made by manufacturer members.

(3) Information: Special patent service such as that conducted by other national associations. Bulletins from the national headquarters regularly posting members on the progress of the various lines of work undertaken by the association, etc.

(4) Publicity: Co-operation with existing mediums for the information of the public and aiding members in getting all the possible publicity for the industry through their local connections.

(5) National expositions: A national exposition at the time of the annual association meeting where manufacturers could exhibit their new lines for the benefit of the dealer and jobber only. Very successful with other national associations.

(6) Legal committees: Advice on questions of radio law for members. Aid in combatting unfair legislation, etc.

These six points cover the main suggestions made for the foundation of the association. The editors of THE RADIO DEALER want every reader of this article to write us his opinion on these points, and if possible suggest another way in which this national association can be of direct benefit to the industry at large.

Volunteers are also wanted for aid in organization in various sections of the country. A great many firms have already offered their assistance in this particular. More are wanted.

Marconi Announces Progress at Directing Waves

Tells Radio Engineers of Experiments With Guiding Radio Waves Operating on Low Wave Length

Senator Guglielmo Marconi, who is in the United States as the Guest of the Radio Corporation of America, in an address before the Institute of Radio Engineers and the American Institute of Electrical Engineers in New York on June 20th, gave out some pointers on the recent experiments he has been conducting with means of guiding radio waves.

The talk was the first he had given since coming here. He told how he had devised a method of sending radio waves in a given direction instead of scattering them broadcast.

This, Senator Marconi said, can be done with reflectors which throw a radio wave somewhat in the manner in which a mirror held in the hand of a child throws a ray of light. Experiments along this line, he explained, have been carried to a point where radio waves have been thrown by reflectors from London to Birmingham, ninety-nine miles, and it has been found that by the use of reflectors at both ends it was possible to exchange clear speech at all times between the two places.

With the use of these reflectors, song or speech may be reproduced about 200 times louder than with the ordinary radio telephone devices. It is also transmitted, the inventor said, practically without distortion.

Dangers of the deep, Marconi pointed out, may be lessened by having revolving reflectors placed at points where lighthouses are now used. From the explanation given it appears that the radio wave thrown by such a reflector would sweep the sea after the manner of the beam from a lighthouse but would be far stronger and more serviceable in a fog.

Ships approaching would pick up this wave and from it be able to get their bearings. This, he said, has been tested and a steamer on which it was tried was able to take her bearings within one quarter of a point of the compass.

Then, going still further into the possibilities of this reflector system, he said: "It seems to me that it should be possible to design apparatus by means of which a ship could radiate or project a divergent beam of the short wave rays in any desired direction, which rays, if coming across a metallic object, such as another steamer,

would be reflected back to a receiver on the sending ship and thereby immediately reveal the presence and bearing of the other ship in fog or thick weather.

"One further great advantage of such an arrangement would be that it would be able to give warning of the presence and bearing of ships, even should these ships be unprovided with any kind of radio."

These inventions, Marconi said, are the results of experiments in short wave length radio. In the development of this means of communication the long wave lengths have received so much attention that the possibilities of the short waves have been generally overlooked. With a wave length of three and one-half metres, he said, he has reflected radio signals six miles, and in the experiment in England when they were reflected ninety-nine miles, fifteen-metre wave lengths were used.

In pictures thrown upon a screen to illustrate the lecture his reflectors looked like peculiar arrangements of wires upon towers or masts.

The inventor made the prediction that the day will come when the ignition apparatus of automobiles or motor boats will have to be screened to prevent its interference with radio waves. He also prophesied that it will be necessary in the future to carry a Government license for transmitting.

The interference from ignition systems is such, he said, that a shortwave receiver will act as an accurate device for testing whether such a system is working properly. Some motorists, he remarked, would be shocked if they knew how badly their ignition systems work.

Discussing the idea of sending radio messages around the earth, the inventor said he had obtained results which "go far to show the relative facility with which radio signals can now be sent from England to Australia and seem to indicate there is something in the idea of the wireless waves travelling around the earth by various ways and remaining at the antipodes."

To overcome "static" interference—he explained, he first determines the strength of the signal sent by means of a measuring apparatus and then makes the signal strength equal to that of the distant transmitting station.

About Advertisers

THE RADIO DEALER has made every effort to scrutinize the advertising matter printed in this paper. We believe every advertiser is reliable and will make good in his printed word.

THE RADIO DEALER will do its utmost to keep dishonest advertisers out of these columns—the fly-by-night chaps, the stock-selling folks and the fakers generally cannot buy space in THE RADIO DEALER.

Advertisers must make good, and we want every reader to feel that he is trading with honest, reliable business men when he trades with *our* advertisers. If any reader finds a dishonest advertisement in this paper we will deem it a pleasure to see to it that the advertiser makes good.

The laws of New York State protect buyers against fraudulent advertisers, and THE RADIO DEALER will support the Associated Advertising Clubs in any campaign they make to cleanse the radio trade of irresponsible and dishonest advertisers.

“Static”—The Radio Alibi

In Which the Radio Dealer Is Asked to Listen to Reason, Not to Make “Reasons” for Trade Fluctuations

By PERCE B. COLLISON

Publicity Manager, Cutting and Washington Radio Department

An appalling number of stores that during the recent “radio boom,” (now alleged deceased, or at least in a comatose condition) resembled a Monday morning bargain counter rush, are today bewailing their misfortune and viewing their shelves with increasing dismay. Certain of the weaker brothers, those who entered the game expecting to make a quick “clean up,” are selling out their business at a loss and many of the legitimate merchants are wasting many valuable hours trying to establish an alibi, or otherwise develop an excuse or reason for the falling off in retail trade.

A universal cry is raised against “static” and this much over-worked alibi is dragged out and set to work at every opportunity. Certain misguided newspaper “radio experts,” may the devil take them, utilized much space in their columns just recently to inform a mystified and credulous public that they were going to experience all kinds of trouble and general dissatisfaction when the hot summer days came. They were told that “static” was an ungovernable evil spirit of the ether whose sole delight was to ruin radio communication, and that any attempt to maintain radio-broadcasting during the summer months was sure to meet with disaster. Doggone those plagued brothers of gloom! They should be thrice cursed because they stated their joy-killing prophecy with such determination and reiteration that the public really believed them.

But what they have stated is not true. Radio-telegraph signals and radio-telephone signals are vastly different. In the one, communication is carried on by means of dot and dash signals sent at a comparatively high speed and the loss of a small percentage of these dots and dashes often necessitates repetition and other vexatious and costly delays. Radio-telephone communication is quite different. Here we have either spoken words or music, instrumental or vocal, and the loss of a syllable, a word, or a few musical notes does not destroy the whole any more than do the numerous coughings and sneezes in a theater audience, necessitate the cancellation of an opera.

I will grant that these disturbing

noises do annoy a person but they have never kept any great percentage of people away from the theaters. Neither should they prevent the public from enjoying radio-broadcasted concerts. I have listened to full evening programs at least three nights a week for the past three months, (and the static at times rendered telegraph communication almost impossible), I have used a supersensitive regenerative receiver incorporating three steps of audio-frequency amplification and sometimes a loud speaker when I felt as though I needed a little “noise” and at no time has “static” destroyed any large portion of the evening’s program. Try it yourself. Then tell all your customers the truth. Tell it as though you believed it and demonstrate it if possible.

Therefore, I think it can be safely stated that “static” is an alibi, not a reason.

Instead of alibi-ing away these precious hours we should enter upon a campaign of education. The reason why we are not selling apparatus today is because we do not know how to sell radio equipment! A period of clever press publicity aroused public interest to a fever heat and they rushed out to buy equipment wherever the mystic word “Radio” was displayed. Any person who could wrap up a package and learn the names and recognize certain pieces of apparatus was kept busy supplying the demand. And what an awful conglomeration they did buy! Crystals, phones, wire, tubes, batteries, transformers, variometers, condensers and all the little odds and ends that go to make up an equipment, these they grabbed and with a few hastily scribbled wiring diagrams and an earful of advice from the “radio expert” usually found in such stores, they hurried home to build a complicated regenerative set and get their share of the “wonderful broadcasted programs.” Did they get their share? Their share of trouble and dissatisfaction, yes.

Many of them, with fatter pocket-books, went further and purchased elaborate but really inefficient and improperly-designed cabinet sets with loud speakers. These plutocrats usually got better results and in some

cases actually got something out of it all. But knowing nothing at all about the proper adjustment of these supersensitive sets and less about the theory of operation they often spent many an hour trying to get clear signals instead of frightful ear-splitting howls. And when their music-loving neighbors came in to be treated to a demonstration of this latest “indoor sport” they usually found it difficult to control their emotions.

Whose fault is all this? There is only one answer—the Radio Dealer.

If the Radio Dealer had assumed some responsibility and realized that radio is an engineering science not yet entirely free from imperfections, and that it requires at least a rudimentary knowledge of radio theory either to construct or operate a regenerative receiver with steps of either radio or audio-frequency amplification, and if he had cautioned the frantically buying public and endeavored to dissuade them from buying the most complicated sets until they had either a few weeks’ experience with a simple crystal set or had put in a few hours of study of the subject, there would not now be this sudden and discouraging slump in the retail market. As in everything else, the race is not always won by the swift.

Radio Dealers must establish “service stations” where intelligent and authentic information is available. They must eliminate those precocious youngsters—those self-styled “radio experts”—from their sales staff and put in their stead sober minded practical salesmen who know what to sell and, what is more important, what not to sell.

Automobile distributors long ago learned that the only way to sell automobiles to the public, and to keep them sold, was to instruct the purchaser thoroughly in the operation and care of his car. And they spend thousands of dollars yearly to educate the public. You will admit that their investments have paid them well.

But on the other hand there has been a tendency on the part of radio manufacturers and dealers to be rather careless with their operation and in-

(Continued on page 48)

Watch Out for the Radio Stock Promoter

Rush of Radio Has Made Way for the Boomer and the Grafter

By ALEXANDER EISEMANN

President, The National Radio Chamber of Commerce

The radio situation is well on the way to parallel the oil boom, and in the wake of the tremendous enthusiasm generated, unscrupulous promoters and so-called "experts" are relieving small investors of their savings. Several cases have come to my attention within the last few months.

Hundreds of thousands of people throughout the country think that radio is a "gusher," that it brings back in dividends many times the principal invested. Many small business men who would think twice before investing their money in gilt-edge securities, never hesitate when the magic word "radio" is whispered to them. They read of the tremendous strides of the radio industry within the last few months, they hear things on all sides, and make up their minds that the dollars they worked so hard for through many years, should "get out of the bank and get into Radio."

It is estimated that within the last three months, at least 1,250 new corporations have been organized to manufacture radio apparatus. Obviously, all of these cannot have technical skill of requisite standard back of them. And certainly, in all this mass of ignorance and lack of expert knowledge, many of these new corporations must fail. As an instance, let me cite the case of a personal friend, who, despite advice to the contrary, invested and lost \$40,000 in backing a radio receiving set, the design of which conflicted with another manufacturer's patents.

Shoemakers, jewelers, hair-dressers, cloak and suit manufacturers, are stampeding into the radio business, usually forsaking a perfectly profitable business in their haste to get into the much-advertised "radio gold mine." These men, usually keen in business affairs, become enthusiastic when their office boy tells them of a new radio set he made at home, at a cost of only \$2.98! This is an actual happening! Or, a self-styled "radio expert," formerly a wireless operator in the Army or Navy, interests a merchant by suggesting the wonderful profits that lie in store for him, if he will only advance a "few thousand dollars" to put this "expert's" wireless product on the market.

A young man approached me recently and wanted to know whether

I would consider backing an "automatic antenna erector," which operated like a jack-in-the-box and was to be erected instantaneously on all roofs anywhere! This self-styled "radio expert" was formerly a floor-walker in a department store and tinkered around with the batteries when the electric buzzers were out of order! Yet, with all this pathetic lack of radio engineering experience and dearth of business knowledge, it is not improbable that he has found some otherwise keen-minded business man to sponsor his queer project with real, hard-earned cash!

In addition to the basic engineering and financing problems, there is always the manufacturing and marketing problems which must be solved before investments can pay back one penny on their principal. For example, let me cite an instance with which I am familiar: A jeweler decided to go into the radio business and backed a young friend's radio invention to the extent of \$20,000 on the strength of his statement that he could make a good radio set for \$9.00, that could retail for \$25, with a dealer's discount of $33\frac{1}{3}$ per cent. Of course, the young man made up a demonstration set with a cost sheet, which proved conclusively that the set could be made for less than \$9.00. However, a kind friend showed this merchant that while the set apparently cost \$9.00 to make, necessary inspection at each stage of the operation brought the cost to \$10.00. Further, that when large quantities were built, experience had shown that $37\frac{1}{2}$ per cent of the sets would be rejected before the final inspection, and would have to be either repaired, or in some cases, rebuilt. This merchant also learned at the cost of much money, that of every hundred pounds of galena crystal he tested for his sets, $93\frac{1}{2}$ pounds had to be carefully tested and rejected as useless, while only $6\frac{1}{2}$ lbs. of the tested crystal could be used!

Materials were advancing in price, and this merchant also learned that deliveries and manufacture of necessary materials were being delayed for weeks and months, and that in order to get price concessions and early deliveries, he had to buy large quantities of materials, much of which lay on

his hands for months, some never to be used!

The patent situation is another element which should have the investor's attention. Of course, most of the older and more stable manufacturers naturally have their various products thoroughly covered by all the patent protection which the government affords. Most of these responsible designers and manufacturers have been too busy to undertake the prosecution of infringements, but the day of reckoning will come, and those opportunists who are trying, carelessly or unscrupulously, to capitalize the public demand for radio will be obliged to answer for their violations of government granted rights on existing inventions.

Let the investor, before placing a dollar in radio, study it thoroughly. Let him find out whether the man he backs is a reputable business man or an unscrupulous operator. Let him judge, not the isolated hand-made set, but the first outfit made in quantity by standardized machinery.

NEW COUPLER HERE

A high class three coil coupler has been put on the market by the Ultimate Radio Products Company, combining many advantages which are described in their circular.

The entire secondary inductance is not coupled, giving, it is claimed, greater freedom from wave changing in coupling manipulation, greater selectivity, and maximum freedom from static. The winding is machine spaced, giving lower distributed capacity and uniformity. The connections are flexible and renewable, which, the Ultimate company claims, gives freedom from faults common to sliding and other connections. The coupler is ruggedly constructed and electrically balanced, and is designed by experienced amateurs for amateurs. It retails at \$12.

GAINING ON ORDERS

The William J. Murdock Co., Chelsea, Mass., are gradually increasing their production and expect before very long to be in a position to take care of all new accounts.

Do You Mistake "Noisy B Batteries" for Static?

The Greatly Exaggerated Radio Bugbear Is Due in Many Cases to Weak Batteries

By GEORGE G. HYDE

Consulting Engineer, American Radio & Electric Co.

There has been a great deal of comment and discussion of late among the radio dealers and consumers on the subject of summer static.

Static has been painted by some imaginative minds as a great and almost insurmountable barrier between the broadcasting station and the receiver. I have heard many people say that they thought it was about time to "put the radio set away for the summer" since the static would soon be so great that it would be practically impossible to receive anything at all. I have heard dealers tell this to their customers and suggest that they wait until fall when the static is less before buying apparatus fearing that they might become discouraged and dissatisfied with the apparatus.

There is no doubt that static exists nor is there any doubt that it is greater in Summer than in Winter but no one seems to know just how bad it is and many have a greatly exaggerated idea of the annoyance caused thereby.

In operating a radio telegraph outfit, especially those using low tone non-synchronous sparks, it manifests itself in sound which may be easily confused with dots and dashes when the communicating stations are at considerable distance from one another and the signals are weak. With spark sets having a musical note, especially those having high frequencies around five hundred cycles per second, and undamped wave transmitters the interference from static is materially reduced since the sound by the signal in the receiver is very different from that produced by the static. In the telephone it may be easily seen that an odd dot or dash here and there thrown in by static is not going to cause the receptor to break his thread of continuity any where near as much as an extra character into a code message.

So far we have admitted the existence of static only in quantities which do not seriously interfere with radio communication but we shall no doubt hear the criticism that such is not the case. Some will agree but others will say that the amount of static interference in summer is such that practically no signals can be heard at all. In my experience as a radio engineer, which covers a period of over thirteen years



GEORGE G. HYDE

is technical director of several large radio concerns, including the American Radio & Electric Company, Clendenning Radio Products Corporation and the Benjamin Products Company.

A graduate of Stevens Institute of Technology, he is at work on the elimination of interference and a vacuum tube that is non-burnable and non-breakable. Young as he is, he has thirteen years of radio experience behind him.

From the above remarks it is apparent that Mr. Hyde is a "comer."

in the United States and Europe, I have never experienced such a condition. The worst static I have ever seen was in the Gulf of Mexico during the months of July and August between the hours of 10 A.M. and 2 P.M., local time, but even this did not make communication entirely impossible.

There exists, however, a condition, due to their own apparatus, which makes communication extremely difficult for many amateurs and some professionals who blame it all on static. This phenomenon manifests it-

self in almost exactly the same form as static and it is almost impossible to tell the difference off-hand. It is known as "Noisy B Batteries," the noises being caused by sudden variations in voltage due to deterioration of the materials used in the battery cells.

A great many people who purchased radio equipment along about the first of the year and have given it moderate use are now noticing the battery noises since their batteries outlived their usefulness and are blaming it all on static. Especially is this annoying when one or two steps of amplification are used, since the voltage variations in the detector plate circuit are amplified and added to the variations in the first amplifier circuit, which sum is in turn, amplified by the second amplifier and added to the variations in its plate circuit and so on according to the number of steps of amplification.

Only a short time ago one of my clients called me on the telephone and asked me if I had noticed the enormous amount of static that was in the air that evening. I went to my set and listened for a while after which I called him back and told him that I could hear practically no static whatever. He then offered to send his automobile for me if I would come to his home and endeavor to locate the trouble. I went and when I put his receivers on my ears the noise was terrific. I disconnected the aerial wire and short circuited both the secondary of the tuning inductance and the tickler. The terrific noise which he called static still continued. I had brought a few new B Batteries with me so we proceeded to replace the old ones with them and immediately all noises ceased. We then connected the aerial, removed the shorts, and listened in. The only extraneous noise to be heard was normal inobtrusive static and signals from radio telephone and telegraph stations were received in good shape.

The dealer's attention might well be called at this point to the fact that most B Batteries are dated and he would do well to watch the dates and see that he gets nothing but new batteries. He should also be careful not to overstock them, as they deteriorate rapidly on the shelves.

Loop Solves City Aerial Problem

By H. F. THORNELL

Eagle Radio Co., Newark, N. J.

Due to the enormous demand in the cities for radio receiving apparatus, the problem of aerials has become a big and a serious one, but, like other difficulties connected with radio, it couldn't be a difficulty long, and now is satisfactorily overcome by means of an indoor loop aerial.

The great majority of city dwellers live in apartments, and comparatively few of these people have been able to install radio receiving sets because of the question of aerials. Only a limited number of aerials can be erected on one roof, and none can be erected if the owner of the building objects, which the majority do, either because they think that there is danger from lightning or because they do not want the outside of the building cluttered up with wires. Then, too, in some cases, where an aerial could be erected, the question of lightning ground and the location of the rooms make this type of aerial impractical. This has resulted in the growth of the industry to date being largely limited to the country and suburban sections of the cities, with the vast majority of the city dwellers without any radio to date.

The rapid growth of the radio industry lately has been so sudden that until very recently this matter has not been seriously studied by radio engineers. The consensus of opinion now is that the solution of the problem lies in the loop aerial and with the advent of a good and practical loop aerial on the market the number of radio enthusiasts will jump ahead again by leaps and bounds.

The loop aerial, to be practical and at all efficient, has required considerable experimental work and careful study. Special kinds of wire and careful designing to reduce the losses to an absolute minimum have resulted in the loop aerial now being practical in its operation and construction. A point overlooked by many people is that the loop aerial must be of such a size that it will not be in the way and take up too much space in an ordinary room, such as is found in a city apartment house.

In a great many cases, other than those mentioned above, the loop aerial is more practical and serviceable than the conventional out-of-door aerial. Due to its marked directional receiving qualities, it is a big help in reducing, and eliminating, the interference from

nearby transmitting stations, and also static electrical interference is greatly reduced, a big advantage in the Summer time. The loop aerial can also be used in any place desired without the necessary delay or bother in running wires, climbing trees, erecting poles, etc. With the coming perfection of radio-frequency amplification

the use of the loop aerial will come into almost universal use for receiving, and it is only a question of a comparatively short time when the aerial will only be used by the ultra energetic person who delights in climbing around high places and who doesn't care about the unsightliness of an outside aerial.

There is not the slightest doubt that radio is here to stay, and with it the loop aerial, because of its portability, directional qualities, reduction of static and other undesired interference and general all-round usefulness in the radio field."

Amrad Protects Dealers and the Radio Buyers

By H. M. TAYLOR

Advertising Manager, American Radio & Research Corp.

That manufacturers are beginning to appreciate keenly the situation referred to editorially last month by the RADIO DEALER as regards selling goods through promiscuous retail channels, is evidenced by the recent announcement of the American Radio and Research Corporation.

This corporation has taken the first steps toward protecting the customer in the purchase of radio goods from questionable dealers and questionable equipment. No doubt other manufacturers will adopt similar methods.

The situation in the radio industry may be compared with the gold rush in 1849. When gold was discovered in California there was a gold rush to the Pacific Coast. Everybody wanted to get rich quick. Some did and some didn't. Today there is a great radio boom and nearly every retailer in the country seems to wish to handle radio equipment and get rich quick. Many will be doomed to disappointment when competition begins, and many business failures may be looked for. After the gold rush things quieted down somewhat, but gold is still mined in large quantities today and is still an important commodity in every day life—to most of us at least. The radio boom will die down, but the radio industry, due to its basic appeal and importance to the community as a whole, will continue and flourish. Again will be seen the working out of the old adage, "the survival of the fittest." Radio "fly-by-nights" will

give up handling radio as well as all retailers who are not prepared to give the public adequate service.

To try and protect the public against the "get rich quick" dealer in radio, the man who does not appreciate the necessity of giving service in connection with his radio sales, the Amrad Corporation has issued to Amrad distributors and dealers all over the country an authorized dealer display card. This card is distributed only to jobbers and dealers of recognized standing, established by careful investigation. The idea is to make the public feel that by purchasing radio equipment, especially Amrad equipment, at any of the stores displaying these signs, they may be assured of fair and courteous treatment, and obtain reputable products of known manufacture. These Amrad dealer display signs are tied up with the general advertising campaign, and while a similar plan has been adopted in other industries, such as the automobile, this is the first time it has been applied to radio.

DUBILIER DIRECTORS

At the last meeting of the Dubilier Condenser and Radio Corporation the following Directors were elected: William Dubilier, President; Claude Marshall, treasurer; Hugh K. Prichitt of Prichitt & Co.; Archie M. Reid, of Prichitt & Co.; Hon. Edmund Bristol, of Toronto, Can., a Director of the Dominion Steel Corporation, and Herman J. Cook, Vice President of the Equitable Trust Company of New York.

Armstrong Amplifies Radio Sets 100,000 Times

The Meaning of the Super-Regenerative Circuit to Radio and to the Radio Trade

By N. BEESEY

Amplifying the ordinary receiving set 100,000 times is the claim for the latest invention of the radio genius, Major Edwin Howard Armstrong, perfecter of the radio audion. With the actual demonstration of his new invention recently before the Institute of Radio Engineers in New York, it needs only a moment's reflection to discover what this means to radio in general and to the radio trade in particular.

"This newest Armstrong idea," says Louis G. Pacent, one of the best known men in the radio industry, and a member of the Institute of Radio Engineers, "has opened up a new field, using extreme frequencies and amplifying without difficulty."

"Practically speaking," Mr. Pacent said in a recent interview, "using the Armstrong super-regenerative circuit as the new invention is called, it is possible to use only two vacuum tubes and a small loop about one meter in diameter and hear any broadcasting station, like WJZ, with telephones lying on a table at a distance of forty to fifty miles from the station."

One might try to tabulate the results which the new invention will bring about, but, as one editorial writer says, "it would take a page." The following are the more important achievements of the Armstrong "super-regenerative circuit":

It is so sensitive that it will abolish outside aerials, even on the ordinary sets.

With the use of this circuit any ordinary set can receive wave lengths under 200 meters. Cost of operating broadcasting stations is thus lessened. Broadcasting stations will be more numerous.

With the super-regenerative circuit the lower the wave lengths receive the greater amplification. Thus it is claimed that broadcasting stations will be able to operate on wave lengths as low as ten meters.

What is more important is that it will make possible the use of reflected waves for communication purposes and bring secrecy to wireless telephony. Thus another drawback to radio will be removed.

The statements made above are only some of the results that one invention will have upon radio, only some of the effects that can be con-

ceived at the present time. When we add secrecy to radio and see broadcasting stations dotting the countryside, because Armstrong has made their operation cheaper, we can reasonably expect greater and greater enthusiasm on the part of the people for radio.

But how is Armstrong doing the things outlined above?

"An outfit equipped with a super-regenerative circuit," he says, "is so sensitive that outside aerials are unnecessary. Receiving sets without outside aerials have been possible for some time, but they have been so expensive that most amateurs have not been able to afford them. With the super-regenerative circuit, inside sets can be manufactured at the same price as those requiring the cumbersome outdoor aerials.

"The other practical result of this circuit will be the ability to detect wave lengths under 200 meters with the ordinary amateur sets. Now that the range under 200 meters is available for the broadcasting stations, the cost of operating will be greatly lessened.

"To illustrate the difference between a receiving set equipped with a super-regenerative circuit and the ordinary set, I have found that a signal which can just be heard with a simple regenerative circuit at the most critical zero point can be heard all over the room with the super-regenerative circuit." (This test was made successfully, by the way, before the experts of the Radio Institute, to whom he was explaining the invention.)

"A short way to describe the super-regenerative circuit," adds Armstrong, "is that one vacuum tube is made to do the work formerly done by three. It has been known for several years that the limit of amplification is reached when the negative charge in the tube approaches the positive. In experimenting I found that it was impossible to increase the negative charge temporarily, for about one 20,000th of a second, far above the positive, and still keep the average down. It is the possibility of increase which permits the enormous amplification which I have demonstrated, and enables me to eliminate two tubes from the circuit."

With the addition of another vacuum tube, as an amplifier, it is explained, it is possible with the same equipment to hear over an entire room. Its possibilities on short waves are also very important. With three tubes it does the work of the super-heterodyne, also invented by Armstrong, which used nine vacuum tubes, but it goes lower in the wave length scale than the super-heterodyne.

On the whole, its most astonishing characteristic is in the fact that it increases its power of amplification inversely as the square of the wave length. This means that the lower the wave length the greater the amplification. Thus if every wave length is cut in half the incoming signal is amplified four times stronger than it would otherwise have been.

With such remarkable possibilities discerned in the invention it is little wonder that the New York *Tribune* recently hailed Armstrong as the "Wizard of Radio."

RADIO IN GREAT BRITAIN

England, that is the English authorities controlling radio activities—the Post Office Department—expects to learn much from the experience of the U. S. A. in regard to wireless.

Postmaster General Kellaway is quoted, in *Telephony*, as follows:

"Fortunately we have avoided the difficulty created in the United States and I hope my proposals will enable this country to have a reasonable service without interfering in other governmental or commercial services."

It is proposed that the Kingdom shall be divided into areas centering on the eight principal cities, each area to have one or two broadcasting stations. These radio-telephone broadcasting stations will be established at the discretion of the postoffice and permits will be issued to only qualified British firms that are bonafide manufacturers of wireless apparatus.

These stations will be limited to 1½ kilowatts and to wave lengths that will not interfere with other services. Normal hours for broadcasting will be from 5 p.m. to 11 p.m. with no limit on Sundays. Licenses for the installation of receiving sets will be issued. Licenses will be issued from all post offices at \$2.50.

Explaining the Loud Speaker to Your Crystal Set Customer

By C. M. HUNT

Sales Manager, Raymond Radio Corporation

Among the thousand or so constantly recurring questions which make the Radio Dealer's life miserable is the one:—"Can I use a loud speaker with this Crystal Set?" Invariably, the answer is a brief "No," or else a statement that the signals for such an outfit would not be audible in a loud speaker.

We are not on the stand to deliver a lecture on patience, for we, as manufacturers, have little enough of it. Please remember that the dealer pesters the producer with questions which are even more childish on the surface. We have found that it pays to analyze such things, as there is generally a real reason in back of it all. We have devoted time and money to the end that new dealers in the radio field might be educated so far as was necessary to properly sell their line. The dealer, in turn, must be willing to help his customer, and particularly the beginners in radio.

In the last issue of the RADIO DEALER, the writer attempted to give a few selling hints on the Crystal Receiving Outfit. Let us assume that you, Mr. Dealer, have sold an outfit along the lines suggested in the above mentioned article. The customer asks the old question about Loud Speakers and it may then be assumed that he is again ready to purchase. At this point, proceed to explain the method of attaining the result which he desires. If the Crystal set has been properly designed, the wiring correctly spaced and insulated and the component parts well made, it will be adaptable to your purpose. Companies turning out products of this nature will, as a rule, be able to supply detector panels and cabinets or two stage audio frequency panels or cabinets. These, of course, should match the crystal set in height of panel, arrangement of binding posts and so on. The customer may, perhaps, purchase a two-stage amplifying unit. To use this, it is only necessary to place it to the right of the crystal set, connect the telephone binding posts on the crystal set to the two input terminals of the amplifier unit, hook up on batteries for the vacuum tubes in this amplifying unit, and connect a standard make of loud speaker to the telephone connections located at the extreme right of the amplifier

unit. If the signals from the local broadcasting station were heard in the original crystal set with a fair amount of signal strength, these same signals should then be audible at a reasonable distance from the loud speaker. Since the signals are originally detected by the crystal method, they must of necessity be pure and undistorted ones. The customer may wish to receive signals from a broadcasting station located at a greater distance from his home. In that case, it is advisable to sell him a vacuum tube detector unit, to which can be added the two stage amplifier unit and finally the loud speaker. This detector unit is connected in exactly the same manner to the Crystal outfit, as was suggested above, when using the two stage amplifier. In this case, however, it is necessary to remove the cat whisker adjustment from the surface of the crystal or by some similar method, to shunt the crystal unit in the circuit. If either of the above suggested arrangements are followed

out, the customer will be able to retain his original crystal set and possess himself of a wireless receiving set capable of energizing a loud speaker at a saving of from ten to fifteen dollars as compared to the cost of a complete set containing a detector and two stage amplifier.

It is obvious, of course, that a number of the old time dealers in radio know all of these facts, and it is also true that a very large majority of the dealers who have recently entered this merchandising field do not appreciate the fact at all and consequently are losing opportunities every day to get repeat orders from their customers.

DALLAS DOINGS

The Radiophone Supply Co. uses large space in local dailies to tell the public they have a very complete line of "everything" that is standard and also advertises free concerts every evening.

The Ess-Tee Radio Co. is capitalized at \$100,000 and offer "all necessary parts."

A petition in bankruptcy has been filed against the Wald Electric Mfg. Co., Inc., 248 Tenth Street, Brooklyn, by the Mitchell-Reed Co., \$401; the James Goldman Co., \$1,516, and Edward Bennett, \$290.

St. Louis Radio Show to Come This Fall

A Radio Show in St. Louis, Mo., is announced during Fall Festival Week in that city from October 4th to 7th inclusive.

The show, which is to be annual affair, will be held under the direction of the St. Louis Radio Association, in conjunction with the Missouri State Radio Association Convention.

The show committee claims that the time chosen for the radio week is especially suitable for three reasons:

The week beginning October fourth is known as the annual Fall festivities, while on the night previous to the proposed opening of the show, the Veiled Prophet parade is held, and it is the biggest night of the year. Again, it is the beginning of the best radio season, and the "St. Louis Post Dispatch" will have their new 500 watt broadcasting station in full operation at this time, so that demonstrations at the

show are expected to arouse considerable interest.

Lastly, the Missouri State Road Association, as well as other organizations are holding conventions in St. Louis during the week which will bring large crowds of visitors to the city.

All communications with regard to the show should be addressed to the committee.

VALUABLE BULLETIN

Every wholesaler and manufacturer of radio equipment (and every salesman) ought to have a copy of The Radio Service Bulletin, published by the Bureau of Navigation, Department of Commerce, Washington, D. C. This is a bulletin for practical men and every business man can get early news on new stations, new inventions, etc., etc. Send your government 25 cents and get on the list for this bulletin.

“Radio Dealer” Starts Trade Mark Bureau

To Help Radio Industry in Establishing Patents on Trade Marks for Radio Equipment

Owing to the present condition of affairs in the Patent Office which makes it almost impossible to secure a certificate of registration for a trade-mark in less than nine months or a year, notwithstanding the most diligent prosecution, the RADIO DEALER has deemed it absolutely necessary to establish a separate Trade-mark Bureau for the industry where manufacturers and dealers in radio apparatus and supplies may deposit their trade-marks for a nominal sum and promptly receive in return a certificate of such deposit that may later afford valuable evidence of the proper ownership of and rights in the said trade-mark.

The dispatch with which such registrations may be obtained and the nominal cost thereof will, it is believed, result in a practically complete regis-

tration of all radio trade-marks in use so that within a comparatively short period of time, an investigation of the records of this Bureau will show at a glance (and with a much greater degree of surety than is to be had from a search of the Patent Office records) whether or not a given trade-mark is anticipated or not.

There will be no limitations on the character of trade-marks that may be registered in this Bureau, provided only that they have been applied to or are intended to be applied to radio equipment or supplies, nor will it be required that the mark shall have first been used in interstate or foreign commerce which is a prerequisite to Federal registration.

Those desiring to register their marks in this Bureau should make application to the RADIO DEALER TRADE-

MARK BUREAU, 4907 Potomac Avenue, N. W., Washington, D. C., sending at least six copies of the mark to be registered and a letter *in duplicate* setting forth (1) the name and address of the applicant; (2) the date of adoption of the trade-mark; (3) the date of first use (if any) of the mark; (4) kinds of apparatus or supplies to which it is appropriated; (5) the essential features of the mark; and (6) remittance of \$5 to cover the cost of registration and certificate thereof.

Those desiring to ascertain whether a trade-mark which they have adopted or want to adopt is anticipated by any mark registered in the Bureau should send a copy of the mark and a statement of the goods to which it is to be applied and remittance of \$2.

Standardized Terms For Radio Business

By general use and through the deliberations of several radio conferences, radio terms are becoming standardized. A process of elimination has already begun and many words are going by the board. Instead of the bothersome old nuisance “static,” for instance which has received as much publicity as a great actress, “atmospheric disturbances” has been suggested. “Atmospherics” is another suggestion to replace “static.”

Other substitutes and changes are: For the title of triode employed in one of its regular modes use “rectifier triode,” “amplifier triode” and “generator triode.”

In describing couplings of high frequency circuits use “resistance coupling,” “inductive coupling” or for self or mutual inductance, “capacity coupling.”

For the generic title for a system of conductors for radiating or absorbing radio impulses use “aerial.”

For an open circuit aerial use “antenna.”

For a closed circuit aerial use “coil.”

For a receiving apparatus in which beats are produced by a special local oscillator use the word “heterodyne.”

For a receiving apparatus in which the same tube is used for generating oscillations and detecting use “self-heterodyne.”

Classification of different type waves generated by radio transmitters.

Type A—Continuous waves (CW) Waves that in the permanent state are periodic and such that their successive amplitudes of oscillation are identical—undamped.

Type A-1—Manipulated continuous waves. Continuous waves which the amplitude or frequency vary under the action of hand telegraphic manipulation.

Type A-2—Continuous waves with audio frequency modulation. Waves, of which the amplitude or frequency vary according to a periodic law of audible frequency. Commonly known as interrupted continuous wave, ICW.

Type A-3—Continuous waves of speech modulation. Continuous waves of which the amplitude or the frequency vary in accordance with speech vibrations—radio telephony.

Type B—Damped waves. Waves composed of successive trains in which the amplitude of the oscillations after having reached a maximum decreases. Waves of spark emanation or any other transmitters having a similar decrement to the spark.

Note 1—If in wave transmitters the rectifying plate voltage is not substantially constant direct voltage the station should be classed under Type A-2.

Note 2—In ICW transmitting stations if the variation of the wave length or frequency of the transmitted wave is effected in a gradual way the station should be classed under Type A-2. If the variation in frequency or amplitude is abrupt it should be classed in Type B.

The recommended definition of an amateur is one who operates a radio station transmitting, receiving or both, in a non-professional way merely for personal interest or in connection with an organization of like interest.

MAKE SETS IN MICHIGAN

The Michigan Radio Corporation, organized with a \$400,000 preferred stock and \$400,000 common stock, will manufacture radio equipment on a large scale, and have already started production. They will manufacture complete receiving sets, as well as all parts except head phones.

National Radio Exposition Opens at Chicago June 26th

The National Radio Exposition opens at the Leiter Building, Chicago, on June 26th, running for the week. A number of interesting contests for amateurs and fans have been announced, as well as some interesting meetings for the trade.

Early reports indicate a good number of exhibitors, many coming from quite a distance. The following program has been announced:

There will be one contest for speed in receiving Continental code. In this there will be two classes, one for male and the other for female, with three prizes in each class. The details of this contest are being arranged by a committee composed of L. R. Schmitt, United States radio inspector for the ninth district, and Alfred Thomas, Jr., district manager of the Radio Corporation of America.

Another contest upon which a committee is working is for the construction of the best home-made outfits from a standard set of specifications. This contest committee is composed of J. C. Hail of the City Hall station, WBU; F. D. Pearne, electrical department, Lane Technical High School, and Professor R. E. Hughes of the Evanston High School. Other contests are to be for the construction of a two-stage amplifier and detector, a loud speaker, and an indoor aerial. The plans for these are being worked out by G. H. Jaspert of station KYW and N. E. Wunderlich. An advisory committee consists of J. Elliott Jenkins, chairman; J. C. Hail, W. S. Hedges, R. E. Hughes, G. H. Jaspert, F. D. Pearne, E. C. Raynor, L. R. Schmitt, Frederick Smith, Charles A. Sloan, Alfred Thomas, Jr., and Norman E. Wunderlich.

This committee decided to provide an educational program which will give the visitors to the exposition a liberal education on radio in addition to viewing the exhibits. Each day open forum discussions will be held, with a prominent speaker along some particular line at each meeting.

After the address by George E. Carlson, commissioner of gas and electricity for the city of Chicago, the man who is responsible for the first municipal broadcasting station ever erected, on Monday, June 26, a meeting of manufacturers will take place.

Tuesday at 2 p. m. a meeting of jobbers will follow an address by Paul

A. Westburg, president-elect of Chicago Rotary Club No. 1.

Wednesday, 2 p. m., meeting of retail dealers; address by George B. Foster, assistant to the vice-president of the Commonwealth Edison Company.

Thursday, 2 p. m., meeting of farmers; address by S. R. Guard, publicity director of American Farm Bureau Federation. Evening meetings and question box.

Friday, 2 p. m., meeting of civic industrial radio clubs of Chicago.

Every class interested in radio will have special sessions during the week. In addition to these meetings there will be many features and demonstrations. A receiving outfit will be installed by the Westinghouse broadcasting station, where all broadcasts may be heard by visitors.

The technical schools of Chicago will not only display radio parts and outfits they have made, but will actually manufacture at the exposition. Dancing by radio music will be another feature. Space will be given over to the Army, Navy, Department of Commerce, weather bureau, Boy Scouts, Girl Scouts, Sea Scouts and Campfire Girls for radio displays. Prizes will be awarded every day.

WELL MADE HEADSET

The T. B. H. Radio Head Sets are correct in design and exhibit their high grade workmanship.

These head sets are light in weight, sanitary, durable and super-sensitive.

Specifications on the T. B. H. are: Resistance, 2,000 ohms; Cord, 6 foot black, moisture proof; Coils, wound with best grade copper wire, enamel insulation; Cap, genuine hard rubber; Magnets, best grade magnet steel.

Inasmuch as the life of a receiver depends, it is admitted by experts, upon the permanence of the magnets, the T. B. H. is properly perfected.

The diaphragm is rust proof and the headband is sanitary and stays in position.

All T. B. H. head sets are of equal type; all match in tone and volume and can be featured by all dealers with satisfaction.

They are made by the Telephone Book Holder Corporation of Danville, New York.

Radio Spreads Music

Introduces Classics to People Everywhere

Frank D. Waller, vice-president of John A. Firth & Co. of New York, was quoted in an Atlantic City newspaper, the other day, as follows:

"Through radio, a large number of people are introduced to really good music. They grow to love it and after hearing it over the 'phone, they want to have it in their own homes to play when they are in the mood for it.

"The radio-phone acts in the capacity of a salesman for the talking machine men, and it is only natural that they should endorse it. I remember when the talking machine was first placed on the market, the piano manufacturers rose up in arms against it and determined to squelch the talking machine makers, thinking they would hurt their business. But the innovation helped the piano, and that is just the way the radio-phone will act."

Mr. Waller was at the Ambassador Hotel for a few days.

GUARANTEED BATTERIES

Among the many radio products manufactured by the Wilmington Electrical Specialty Company, Inc., of Wilmington Delaware, is the Dragon Radio Storage Battery.

Some of the features credited by the company to this battery are: Plates guaranteed for two years; separators made of the most durable material obtainable for this purpose; jars of fine Para rubber; and chemicals of special formulae, found by tests and experience to be especially suited to radio batteries. Dragon batteries are shipped fully charged and ready for immediate use. Each battery is inspected before it is shipped. All are guaranteed as to capacity and to be electrically and mechanically perfect. The prices are listed at from \$17.10 to \$35.60 for capacities ranging from 6 volt 40-60 A. H. to 6 volt 120-150 A. H.

The Wilmington Electrical Specialty Company also assures purchasers of the quality of its other radio products, which are covered by a guarantee that they are free from defects in material or construction or against electrical breakdown not due to misuse or abuse. A money-back policy in event of dissatisfaction has been adopted by the company.

MUNICIPAL STATION

Plainfield, N. J., has been granted a special license for broadcasting. It is said that this is the first Jersey city granted a limited broadcasting license.

How Patents Protect Your Radio Ideas

By CHAUNCEY P. CARTER

Every manufacturer or merchant who is alive to his business and attaining any measure of success in it, must keep his eyes open for new ideas of one kind or another and when he hits on a new idea should immediately consider whether it is possible to prevent its use by competitors. The law provides for the monopolization of various types of original thought when embodied in practical form and it is well for business men to have a general idea of these types.

In the first place, one may obtain in this country two kinds of patents, one for new and USEFUL inventions, such as a new typewriter, a new universal joint for automobiles, a new incandescent light, a new means of broadcasting the human voice, etc. These patents give one a monopoly in the patented article or process for seventeen years from the date the patent is issued which is often several years after the invention is discovered or the patent applied for.

The other kind of patent is issued only for new and ORNAMENTAL invention, or the so-called "design patent." Such patents are not available for new inventions that have utility of a practical sort, but only for inventions that have no practical utility but are novel in an ornamental sense, as for instance a new design for a rug, or a new design for a container, or a new design for an automobile radiator or radio set WHERE SUCH DESIGNS ARE DIRECTED NOT TO GREATER UTILITY BUT TO THE APPEARANCE OF THE OBJECT. These patents may be had for three and one-half, seven, or fourteen years, at corresponding fees, depending on the desire of the patentee.

Then there is the COPYRIGHT law which provides for monopolization of novel compositions having artistic or literary merit as for instance books, pictures, moving picture scenarios, etc. which may be registered in the Library of Congress for protection and also LABELS and ADVERTISEMENTS which possess artistic or literary merit or both and which are registered in the Patent Office. Many manufacturers fail to take advantage of the provision for the protection of the literary and artistic merits of their labels and advertisements for which they oftentimes pay large sums of money, with the re-

sult that others are free to copy these meritorious features.

Copyrights endure twenty-eight years with the privilege of renewal in most cases, for a further like period so that no one can complain of the duration of this form of protection. Moreover, by virtue of certain international copyright conventions into which this country has entered, a copyright effected in this country is automatically extended to various Latin American and other countries without additional expense or action on the part of the copyright claimant.

Last, but not least, there is the trade-mark law which provides for the protection FOR AN UNLIMITED TIME DURING THE USE OF THE MARK of marks that must be novel only in the sense that their application to certain products is novel. That is to say, the word SNOWKING may not be novel in itself but it may be quite novel to apply the same as a trade-mark to automobiles.

In such case, the person or firm applying it in this way is entitled to a monopoly to the extent that no one else may apply the same or a similar word to the same or similar articles for a like purpose. Trade-mark registration is at present entrusted to the Patent Office although it is hoped that there may some day be a separate Registrar of Trade-marks just as there is now a separate Registrar of Copyrights.

Remember, therefore, that the man with plenty of new ideas is not always the most successful, as it often happens that a man with one new idea WELL PROTECTED will win out. The best advice that can be given, therefore, is to submit every new idea immediately to someone skilled in such affairs, as for instance a patent attorney or trade-mark specialist, for an opinion as to what protection, if any, is available under the law.

(Copyright U. S. A. and foreign countries, 1922.—Chauncey P. Carter.)

WELL DESIGNED UNITS

Transmitting, receiving and amplifying units designed especially for voice receiving, are produced in the factory of the Wireless Phone Corporation, 193 Ellison street, Paterson, N. J.

PREVENTS FILAMENT DAMAGE

As a means of protecting the delicate filament of the vacuum tube, the Pignolet Instrument Co., Inc., New York, have perfected a radio voltmeter to measure the voltage of the current entering the filament.

Of course, when the filament current is too high, its life is materially shortened. Even a very small excess of current will reduce the life of a tube 25 per cent. It is not satisfactory to try to regulate the current by observing the brightness of the filament, for while this is often done, it is most uncertain, for what one person may consider the proper brightness, another would consider either too high or too low. Manufacturers of vacuum tubes themselves recommend voltmeters for the measurement of filament current.

Other uses for the radio enthusiast are to be found in the Pignolet Radio Voltmeter. It tests storage batteries, disclosing the state of the charge or discharge. If a battery that has been run down is being recharged, its state of charge can be determined by connecting the voltmeter across the terminals of each cell in turn. When the battery is being charged at a normal rate, a completely recharged cell will show the voltage reading. Dry cell batteries may also be tested by the Pignolet instrument, as well as condensers, for grounds and short circuits. It is made in three types, the portable, mounted on a base $4\frac{1}{4}$ inches in diameter, a flush type for switchboard mounting and the surface type for switchboard mounting.

SHOWS FAITH IN RADIO

Henry Kirby Davies has opened up his new store in the old Herald Building at 603 Sixth Avenue, New York City. This store is conceded to be one of the prettiest in New York, which means in the whole of the United States. Nothing else but Radio will be carried here, and friend Davies will handle nothing but John Firth & Co. equipment.

Some of the wise birds, who are chirping that radio is only a fad, and will die real soon, will lose heart when they learn that H.K.D.'s grand entry into the radio field in this location is for a period of five years, and that quite a few thousand dollars was spent to fit this store up, and a palatial demonstration room, which even the phonograph business, in all its glory, could not boast of, will be here.

Louis R. Barbalater will be in charge of this store. Louis was instructor of radio in the A. E. F. of the U. S. Army and has had eleven years experience in the radio field.

THE RADIO DEALER

THE RADIO TRADE JOURNAL

Published monthly at 1133 Broadway, New York, N. Y., in the interest of Dealers in Radio Supplies.

Telephone: Watkins 8926-7

Harry M. Konwiser.....Publisher
 Laurence A. Nixon.....Managing Editor
 N. B. Zimmerman.....Editor
 A. L. Konwiser, B. S.....Technical Editor
 Bernard J. Farrell.....Associate Editor
 Eugene J. Scanlon.....Associate Editor
 John R. Hall.....Research
 Elmer W. Moore.....Advertising
 F. Murray Rapport.....Advertising
 H. E. Bennett.....New Jersey
 Wm. B. Wilkinson, Jr.....Philadelphia
 J. M. Casper.....Bronx
 J. A. Doucet.....New England
 Jos. J. Ollendorf.....Circulation Manager

Subscription: One Dollar the year, payable invariably in advance.

Circulation restricted to manufacturers, jobbers and dealers in Wireless Equipment.

THE NATIONAL PUBLICATION
 OF THE RADIO INDUSTRY

Chicago office: C. L. Geesey, Manager, 60 Washington St.; Phone: Dearborn 4053. Coast office: suite 910-456 Spring St., Los Angeles, Calif. Pittsburgh, Penna., Union Arcade Bldg. Southern office: 730 Gravier St., New Orleans. New Jersey office: 845 Broad St., Newark, N. J.; Phone, Market 4659.

Advertising Rates on application. Detailed Statement of Circulation and Other Information for Advertisers Furnished on application.

Application for entry as second class matter pending.

JULY, 1922

Selling Standard Radio Apparatus

Complaints are being received almost daily by THE RADIO DEALER against the great amount of "junk radio apparatus" on the market, and when the complainant is asked whether this "junk" has been bought recently he says, "No, I bought it three months ago," or words to that effect.

In the hey-day of the era of shortage—in the hectic get-it-quick days of last winter and this past spring—a lot of faulty equipment was produced.

And now the harvest is being reaped and, as was expected, the retailer is the victim, for the purchasers are presenting their complaints to the retailer.

This is but another object lesson, learned by bitter experience, and it behooves the retailer to ask the manufacturer and jobber to guarantee his product *in writing*.

The honest radio manufacturers and their jobbers readily replace apparatus not up to the mark.

Let's stop fooling the dear public with "junk" apparatus—it cannot be done successfully, and the one certain way for the dealer to prevent

Broadcasting Better Stuff

There is apparently a demand and it should be filled for "better broadcasting service."

Retailers and jobbers, as well as manufacturers, are hearing many criticisms of the present broadcasting service—from the general public.

The general public is not acquainted with the fact that broadcasting stations bring no revenue and cost considerable sums of money to operate.

It is not fair to criticize the broadcasting concerns who are now making radio popular. These concerns are, of course, benefiting by the indirect advertising acquired by them—but the general public hasn't sensed the fact that *for the present*, at least, the advertising returns are of no appreciable quantity.

The average citizen who buys a set, say at \$200, expects to receive real entertainment. This man cavils at the "Man In the Moon" stories when this feature becomes a regular nightly event, and the same goes for duplication of baseball scores and market reports.

What's to be done?

The present answer to the disgruntled buyer of a \$200 set is "to tune out." Is this fair to the set owner? Is he entitled to a better answer?

These are important questions that will have to be answered in proper manner, and very soon. When the Fall radio boom comes along what will the radio dealer say to the customer?

Will he promise "good concerts"? Will you promise "all-day service"?

It is obvious that if "good sets" are to be sold in good number, the makers of good sets should be able to promise "good concerts."

A great deal of the present entertainment—let us be fair—is trash. Whose fault is it? Isn't it time to broadcast "good stuff"?

complaints about radio "sets that won't work" and parts that are not properly made is to exact a written promise from the maker to make good on equipment that will not develop proper entertainment.

Radio manufacturing is a science, if you please. It is not a fact that every person who "knows" electricity is an expert radio man. That theory has been disproved.

THE RADIO DEALER has seen evidences of failure on the part of genuine electrical experts and has observed successes on the part of newcomers to the world of radio science.

And so, as with the maker, is it with the jobber and wholesaler. Some of the leading wholesalers in the radio field are not electrical experts. They are business men who have operated their new businesses along business lines.

But, getting back to the retailer, he—in the final analysis—is the real sufferer from poorly made radio equip-

ment. The retailer may buy in good faith and sell the same way, but if the apparatus is not up to the requirements he loses out and radio suffers.

Now is the time "to get set." Start getting right for the big fall trade, which will be limited only where there is no broadcasting nearby. After all, that is the essence of success in the radio industry.

Provide broadcasting stations in one hundred additional cities in the United States, and several million "sets" will be installed. Let's be ultra conservative and say one million sets will be sold if one hundred cities more become broadcasting centers.

One million "sets" will mean about \$75,000,000 expended for radio.

That's a big amount and that ought to bring a big amount of goodwill to retailers—provided they sell real radio apparatus.

The services of THE RADIO DEALER are available to every retailer in the land for the purpose of aiding in the selling of standard, guaranteed radio apparatus.

Too Much Fake Advertising

Daily newspapers, in the opinion of many reliable retailers, jobbers and manufacturers of radio equipment, are not properly scanning their advertising columns.

This fact is patent to those of us who read these daily newspapers and note therein the many stock offerings, as well as radio equipment.

It is regrettable that all the daily newspapers do not employ the same standards of advertising for radio equipment as they do for general advertising and some of this is caused by their lack of knowledge of radio.

But, if the advertising of "crystal sets that will bring in concerts *from everywhere*" is condoned, because of the status of the Radio industry—if that is the condoning element, what can be said *for* some of the stock being offered via the daily press?

Over capitalized stock offerings are in evidence, everywhere. The former "oil" promoters seem but amateurs alongside some of the promoters of radio stock.

Publishers, in too many instances, it appears, have closed their eyes to these bold advertisers.

The time is ripe for the honest daily press to awaken to the dangers that develop from offering stocks in radio companies **THAT CANNOT POSSIBLY MAKE GOOD.**

Some of these over-heavily capitalized concerns—their total runs close to the billion mark—are pure "blue sky."

In view of this circumstance there is but one thing to be done by reputable publishers. Their duty is obvious, and THE RADIO DEALER believes the daily press will arise to the situation.

HARRY M. KONWISER.

Advertising In the Air

THE RADIO DEALER again registers its protest against advertising in the air. THE RADIO DEALER is against the broadcasting of advertising matter on the 360-meter wave length and believes that some congressional action should be taken to prohibit the use of this wave length, which has come to stand for entertainment and amusement, for advertising of any character.

Readers of THE RADIO DEALER can help prevent a monopoly of the air by powerful stations broadcasting advertising by joining in this protest.

The time to speak is now, the time to act, today. Every reader of this publication is urged to write his congressman today, demanding that stations broadcasting advertising matter be forbidden the use of the 360-meter wave length. Five minutes' time, a two-cent stamp and your representatives and senators will know your position on the matter.

Our Service Bureau

The establishment of THE RADIO DEALER Service Bureau coincident with the publication of the first issue of this monthly has brought to the radio trade a service that can be found in few industries in the United States, so our readers tell us.

When this department was projected the publishers of THE RADIO DEALER felt that there was a demand for service of this kind and determined to give the best possible service to the trade. Inquiries were expected in fair number, but no such flood of coupons was visioned as came in after the first announcement was mailed.

Since the establishment of this special department not a day has passed when several inquiries were not received. Faced with the steadily growing list of would-be buyers to be referred to manufacturers, the Service Bureau of THE RADIO DEALER was forced into the publishing business on its own hook.

We are pleased to announce the pub-

lication of the "THE RADIO DEALER WEEKLY," which will be issued regularly by the Service Bureau of the Radio Dealer organization. A sample copy of the weekly may be had for the asking by anyone in the radio trade.

"The Weekly in no sense will compete with the monthly RADIO DEALER, nor will any attempt be made to carry articles or long accounts of news events," to quote from the first issue of the Weekly, "but brief news items of general interest will be covered each week."

In addition to listing inquiries received by the Service Bureau that cannot be speedier handled by mail or telephone, the Weekly will carry in each issue a list of manufacturers advertising in THE RADIO DEALER, compiled in handy form for the convenience of buyers of radio equipment. Advertising will not be sold in the Weekly to firms not advertising in THE RADIO DEALER, nor will any effort be made to place space with our present advertisers. THE RADIO DEALER WEEKLY is not yet an advertising medium, but is destined to fulfill a mission of service to the trade at large.

Manufacturers who are not yet listed in the files of THE RADIO DEALER Service Bureau should communicate with this bureau at once. Retailers, jobbers or other buyers who are in the market for equipment are invited to take advantage of the services of this bureau, using the coupon that will be found on another page. Absolutely no charge is made for any of the work done by this bureau, manufacturers may receive inquiries without charge and buyers may have their wants listed without the expenditure of more than a one-cent stamp for the postage necessary to carry their inquiry to this office.

Gentlemen of the radio trade, we present to you the Service Bureau, with the desire that you will avail yourselves of its good offices early and often. This is one of our contributions toward establishing the radio industry on a sounder basis.

The Radio Lamp as a New Development

The Capitol Phonolier Company's Instrument Is Both Useful and Beautiful

By R. J. WHITLAW

The logical development of the horseless carriage was the six-cylinder automobile. The Twentieth Century Flyer followed the crude "coaches" of the Eighties, in the natural course of events. And just as naturally the radio-phonograph has been evolved out of the most remarkable advance in electricity in a decade—Radio.

It has been truly a remarkable ten years, and any achievement that was to be outstanding within that

period, even under unfavorable conditions, the makers say. The whole secret of this efficiency is in the Capitol "All-Wave" coupler, a departure which is said to eliminate the necessity of vario-meters, vario-couplers, and loading coils, and is responsible for a remarkably clear long-wave reception. Excellent results have been obtained in New York from points as far West as Chicago.

But the thing itself, the "Phonolier," looks like a beautiful table lamp, and may be used as one, as it stands on the living room table. There is no suggestion of the electrical or the mechanical in its artistic lines. There are no wires to mar its appearance, or to break the illusion of its effect. A one-way plug connects from the receiving outfit within the interior of the lamp to the electric socket. To start the receiving set, all that is necessary is to insert the plug.

Within the lamp is one compact unit, a complete radio receiving set, tuner, detector, two stage amplifier and loud speaker. The simplicity of

grounded as it is on abstruse scientific laws, requires none of the scientific knowledge to run it—or to enjoy it.

Whether the lamp is in use as a radio receiving apparatus or not, the shade may be shut down, and there is an electric light beneath the shade, and two beneath the fringe of the shade for lighting purposes or reading. To all appearances this is a table lamp, until the shade is lifted and one starts to tune for broadcasting.

The "Phonolier" is built of solid



THE PHONOLIER CLOSED
Used as a Table Lamp

period had to be in itself remarkable. It has all been so wonderful that the ancient miracles and fairy stories no longer cause us to wonder. Indeed, we might say that within the last ten years or so most of the fairy tales have come true. Aladdin's lamp, for instance, is now real. Science has brought forth the radio-lamp, the "Phonolier," which we do not rub, it is true, but into which we merely insert a plug, and we can hear, in loud, clear and undistorted tones, by day or night, not only the news of our immediate vicinity but the larger events of the world outside.

And how is it done? With the utilization of any electric light socket, the "Phonolier," which is fool-proof, will give clear and definite results over the great range of from 150 to 3,000

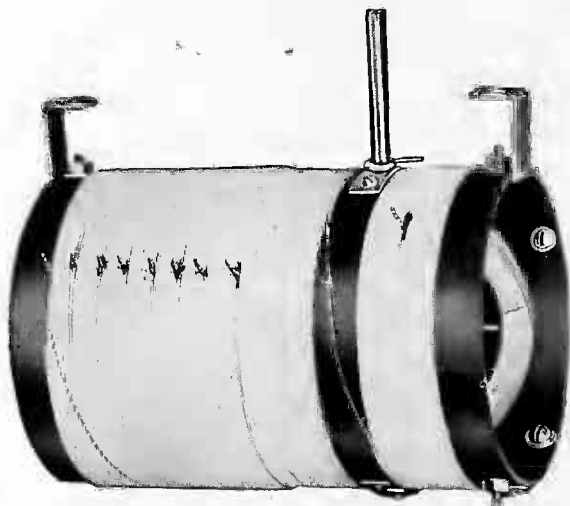

THE ALL-WAVE COUPLER
Makes the Phonolier Possible

the design of the Phonolier requires no scientific knowledge on the part of the owner to operate it. The operator does not have to concern himself with storage batteries, hook-ups or more or less complex technicalities. Thus a radio set of this sort has the same basis of appeal as the phonograph, which, marvellous as it is, and



THE PHONOLIER OPEN
Receives and Amplifies

copper, and finished in bronze, silver or gold with lamp shades of refined and subdued combinations to match or contrast with interior decorations.

The base of the lamp is the loud speaker, and contains an inner horn that increases the clearness and volume of tone but the makers say that they have done away with distortion.

But the real novelty of the "Phonolier," and the thing of which the Capitol Phonolier Corporation, 54-60 Lafayette Street, New York, are proud, is that no outside aerials are required, its scientific construction sees to that. No wires clutter up the set. No knowledge is necessary to enjoy the pleasures of the instrument. It is a beautiful piece of furniture as well as one step further in the development of Radio.

**Non-Leak
Variable
Air
Condenser**

Vernier Type

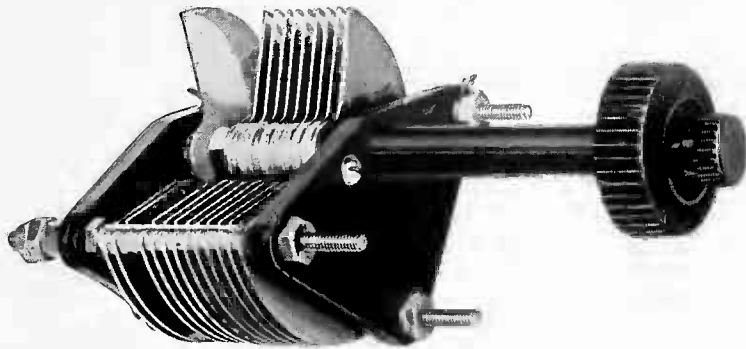

Once station is secured, the Vernier or inter-degree adjustment eliminates remaining disturbing sounds.

THE MORE
UNIVERSAL
becomes the use of
Radio, the more pro-
nounced and insistent
the demand for
GENERAL RADIO
EQUIPMENT

GENERAL RADIO EQUIPMENT

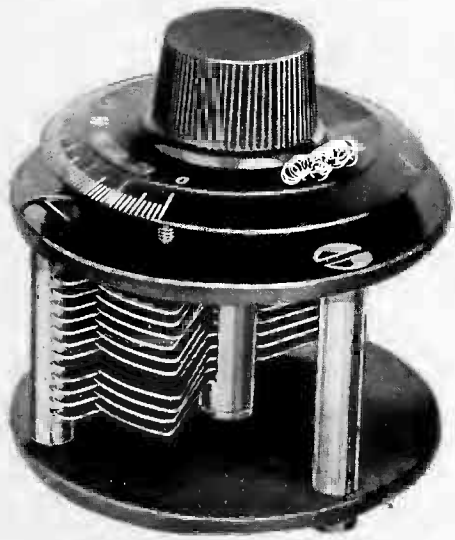

23 Plates
"L" Type Variable Condensers
Plain Type

Dealers everywhere will find it advantageous to stock GENERAL equipment without delay to take care of the immediate and Fall rush.

The GENERAL line will dominate the field because its salability is backed up by satisfactory performance.

The items illustrated on this page are of high standard quality, made to sell quickly and with discounts to dealers that mean real profits.

NON-LEAK AND "L" TYPE Variable Air Condensers with and without Vernier Attachment—11 to 64 Plates—all capacities.

RED STAR, 2,000 Ohms, Professional, 2,400 Ohms, and Long Distance, 3,200 Ohms, all furnished with G .R. Head Band and Cord as illustrated—THE LAST WORD IN RADIO TELEPHONE RECEIVERS!

Do not overlook the sales possibilities of the GENERAL line. Prepare now. Write or wire.



Red Star
Radio Telephone Receivers

General Radio Laboratories
INCORPORATED
7 So. Dearborn St. - - Chicago

Advertising for the Retail Dealer

Making Your Advertising Convince as Well as Argue

DISCUSSING RETAILERS ADVERTISING PROBLEMS

"How shall I advertise batteries?"

That's the query propounded by a St. Louis retailer and he submits a specimen advertisement reading:

"Batteries A and B, for Radio Purposes—all makes."

Not so good.

That's our viewpoint on the above ad.

Why couldn't this retailer advertise along these lines?

Take a standard brand battery—employ cuts and tell the story like this:

A Real Radio "B"—24 Volt—Storage Battery.

Then follow this with a cut of a real battery and explain the Screw Caps, the Insulation, the Rubber Vent Plugs, the Terminal Parts, the Glass Jar, the Connectors and the Heavy Oak Case.

All these are featured in good batteries and every battery maker supplies a lot of literature telling all about the good qualities of their batteries.

Take these "points" and tell them to the prospective buyer, *just as you would if he entered your store.*

Don't ramble on saying "we sell good batteries" when the same space will tell a real story about the "mysterious power" developed from batteries.

All standard batteries have their good points and are worth telling about.

"I am local agent for the De Forest apparatus. Will you suggest some advertising for my local paper?"

This is the problem put to us by a Connecticut retailer.

Featuring the De Forest name is a good thing. It is always good policy for a business to tie up its name with that of a reputable house.

In this case not only feature the word "De Forest" but do the same for the word "Radiophone." The De Forest folks have registered this name and it'll come in mighty useful

to be known as the only radiophone dealer in your town.

Advertise something like this:

"Buyers of radio equipment are asked to investigate the De Forest Radiophone because we want to show them what a real set will do.

"De Forest radiophones are always dependable and meet all requirements."

In the advertising done by the De Forest Company they say that their apparatus is bound to satisfy and that the same is sold on the basis of performance.

A worth-while story—that can be proven. So use it.

Our idea: Not only tie up your name with reputable manufacturers, but follow up their advertising ideas. They won't object and it's good business.

"A complete line of all makes of radio sets and parts."

Then follows a list of prices, of about thirty-five parts, giving merely the names of the makers and the prices.

Rather weak—in a daily newspaper—and we advise our New Jersey reader to employ this sort of advertising in "fan radio papers" but when it comes to daily newspapers, reaching people who don't know the John Jones Co. from the Willie Wilde Co. the advertising should describe the "parts" as well as their prices and we question whether "prices" mean much to folks new to radio.

The daily newspaper ad. should arouse the interest of the people in your town in radio.

Talk to them right out from the shoulder—smash at them with your biggest weapon. Tell them they're missing something by not having a radio set in their homes. And tell them why.

Tell them that the Double Double Receiver gets all the news and concerts out of the air—provides entertainment for young and old and is THE marvel of the age. You can prove it.

PUBLISHES BULLETIN

An interesting bulletin is published by the Colin B. Kennedy Company, radio distributors, on the Pacific Coast. An article is included in the latest issue of their organ, reprinted from the "Radio Broadcast." This explains many of the misapprehensions with regard to loud speakers. The article shows the need for the amplifier.

This is a specialty of the Kennedy company, and several are listed in their catalogue. One type of two stage amplifier is the interior assembly style and is listed at \$55.00. Another is listed at \$85.00. The company lists complete sets at prices ranging up to \$400. The firm are also distributors of many recognized electrical products, including Magnavox, Western Electric and Exide Batteries. Their office is in the Rialto Building, San Francisco.

One of the best features of the bulletin is a little paragraph paying homage to the amateur. "While contemplating," it says, "the wonderful new field of Radio presented by the development of the radio telephone, we should not forget the pioneers of yesterday. In large measure they have contributed to the practical adaptation of Radio as we find it today. It is a noteworthy fact that many of the world's greatest inventions have been made by the so-called amateur.

"It is our hope and feeling that nothing will ever be done to hamper the activities of this class of experimenter to whom we owe so much."

FORMICA PANELS

Formica for radio purposes is made of an especially prepared cotton rag paper, impregnated with a very high percentage of anhydrous Redmanol Resins. This gives it the utmost dielectric strength and insulation qualities. It is formed by presses into a solid block in which the original limitations entirely disappear. It is somewhat harder than wood, but softer than steel in its final form.

Formica is especially handsome in appearance and may be had in black with polished or dull surface and in natural brown with polished surface.



The Greatest Value on the Market!

We have succeeded in producing a headset

TO RETAIL AT

\$9.00

which is the equal in audibility, beauty and construction of products now selling at \$12 to \$15.

And we can make the

PRICE TO YOU

\$4.86

giving you a profit of almost 100% on your investment.

TEKTOR Headphones sell on sight. They are beautiful, comfortable, and easily adjusted—instruments that any professional or amateur will be glad to use.

They are the loudest and clearest magnetic-diaphragm phones on the market. High-grade rubber composition caps, aluminum backs, black woven head covering, navy standard adjustment. Resistance 2200 ohms. Weight 12 oz.

Packed in handsome blue and orange box, making a striking display on your shelf, counter or window.

TEKTOR headphones are the first of a series of TEKTOR quality products which will enable you to undersell your competitors and make a "long" profit.

Send your initial order now and judge for yourself.

TEKTOR CORPORATION

250 West 57th St., New York
Telephone: Circle 8881

TEKTOR

RADIO TELEPHONE HEADSET

THREE REAL LEADERS

The New Amco Adjustable Triple Coil Mounting

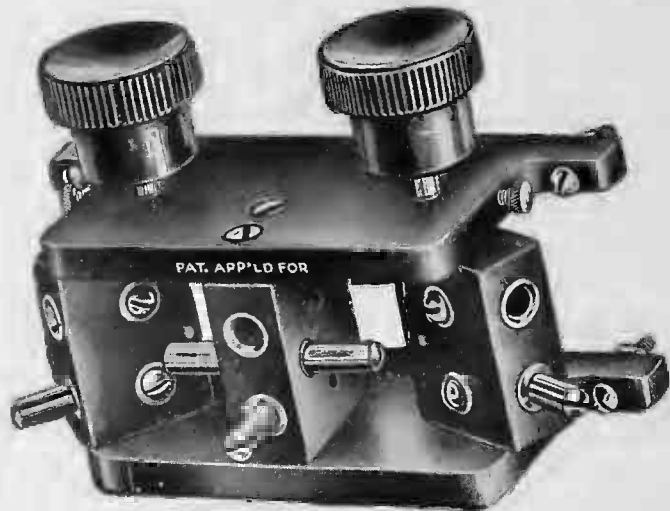

The New Triple Coil Mounting with the following features:

- 1—A patented feature; *locks* the coil in place. This prevents the coil from being thrown out of adjustment once the station is tuned in.
- 2—The *simplest* mounting to install on your set. No rear mounting. Mounts on front of panel.
- 3—The tension on specially constructed bearings is adjustable.
- 4—Constructed of the highest *grade* of insulation material.

Its high polish and fine finish give it a very attractive appearance. All metal parts heavily nickel plated. Not a moulded affair.

THE UNBREAKABLE DIAL

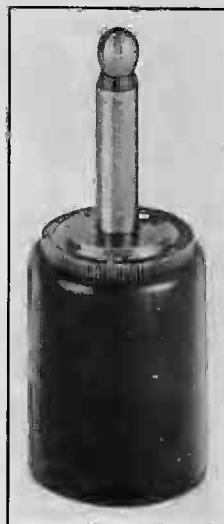

The AMCO UNIVERSAL RADIO PLUG fills a long felt want for a simple substantial plug which can be used with telephone cords having pin tips, spade tips or plain wire ends. NO SOLDERING NECESSARY.



This handsome dial is made of UNBREAKABLE material, highly polished and adapted by the leading manufacturers on the most expensive sets on the market today. The high polish and fine finish make these UNBREAKABLE dials very attractive and fast sellers.

Triple Coil Mounting, List Price.....\$5.00
 3" UNBREAKABLE Dial, List Price... .70
 3½" UNBREAKABLE Dial, List Price... .90
 Amco Radio Plug, List Price..... 1.00
 Our production is large and your orders will receive immediate attention.

Jobbers write for special discount

ASTORLOID MFG. CO., INC.

416 Marcy Ave., Brooklyn

RADIO TUBES *and* TUBING

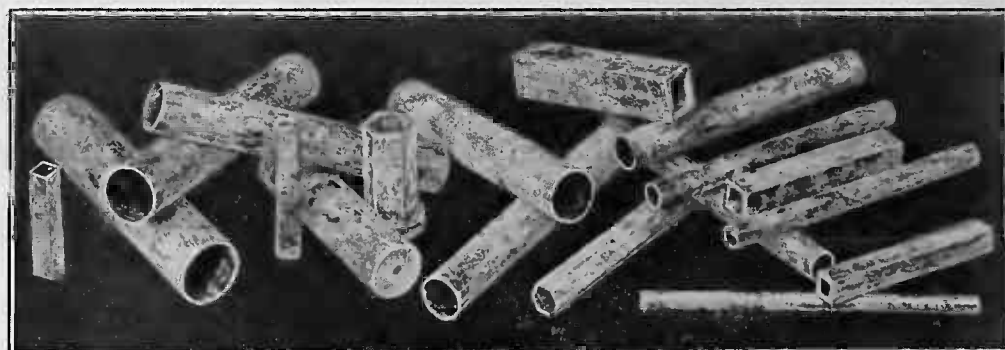

MICANITE RADIO TUBES

Micanite, standard insulation for almost 30 years in the electrical industry, is proving supreme in radio coil work. When the utmost in service is demanded Micanite Tubes will supply it. In all radio diameters, and in lengths up to 36 inches.

EMPIRE OILED TUBING Sometimes called "Spaghetti," for years the standard of the electrical industry, is far ahead of ordinary "spaghetti." It is more flexible, smoother, of much higher insulating value, and of great dielectric strength. It builds a reputation for you that means constant repeat orders. Supplied in yellow, black, and other colors, in all radio sizes, 36-inch lengths. Be sure to get the genuine: "Empire."

MICO TUBES FOR COILS Greatly superior to cardboard for coils. Strong, tough, dense; impregnated with shellac; moisture proof; rolled to form. Better insulation than hard fibre; lighter, thinner, than hard rubber or synthetic products. Diameters: 2 to 6 inches; lengths to 36 inches.

Our products keep customers coming for more. They build the class of trade that means big permanent business. Our complete line includes 55 insulating products. It pays to "hook up" with MICO. Write today for literature and samples.

MICA INSULATOR COMPANY

68 Church Street, New York. 542 So. Dearborn Street, Chicago. Works: Schenectady, N. Y.

Agencies—MONROE BRASS & WIRE CO., Cleveland; G. ARTHUR MORRELL
 Cleveland; ELECTRICAL SPECIALTY CO., San Francisco and Los Angeles

The Local Dealer

He Makes Things Hum in the Radio Industry

By J. W. WELLINGTON
Pres., Matthews Engineering Co.

Never in the history of American business has the job of selling been so squarely and definitely up to the dealer. And the dealer has responded most splendidly. Talk about dealers being asleep! It is all bosh—simply tommy rot! It is time we all sat up and took notice of the fact that dealers and distributors have been and are in the thick of the fight for business—on the real firing line!

The amount of hustle, energy, aggressiveness and good common sense that is being displayed by dealers in every line in big towns and small towns and up in the country villages and at the four corners shows clearly and conclusively that the American merchant is leading the world in salesmanship. We take off our hats to "The Dealer."

The superb faith shown by that much maligned group of sterling merchants so often referred to as the dealer has never been fully appreciated. But hereafter the dealer must be recognized as the element that the manufacturer should co-operate with.

The dealer is coming into his own. We will see more intense cultivation of the dealer than ever before. We will see manufacturers taking the dealer more and more into their confidence. Instead of inspiration talks to dealers we will hear information talks, the things dealers need most to give them inspiration.

Some folks think the dealer has to be cajoled, scared and coddled into selling. What foolishness! It is so perfectly obvious that the dealer buys his stock to sell, rents his store on the basis of its sales opportunities, spends his good money for advertising and salesmen. Would he do all this if he didn't know that his one big job is to sell and turn over his stock as fast and as often as he can?

Let us all wake up and give the dealer due recognition as the most important and influential force in the whole scheme of distribution.

Let's co-operate with the dealer and he will co-operate with us. Just give the dealer a fighting chance with the right merchandise at the right price and you will win every time.

RADIO COMPANIES

Radio companies are still being incorporated in good number, the total for June being about fifty, divided mainly between New York State and Delaware.



ELLING the Lefax story thirteen million times.

Lefax Radio Handbooks will be advertised in fourteen national magazines during June, July, August and September. The total circulation of Lefax advertisements will be over thirteen million. Hook up with the demand which will be created by placing



one of these striking window cards, which we supply free with every order, in your window and putting

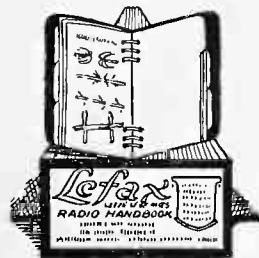

this attractive display, also supplied free, on your counter. The Lefax broadside explains these sales helps in detail. Send for it today.

The ONE unbiased authority on RADIO

NOW you can get ONE authentic source of radio information—not opinions, not hearsay, but tested facts, approved by the United States Government. Every phase of radio is explained—acrial construction, diagrams and hookups of all types of both receiving and transmitting apparatus and the function of every piece of apparatus used. The cream of radio research is always at your finger tips in the handy, convenient, pocket-size, loose-leaf

Lefax

LOOSE-LEAF FACTS

RADIO HANDBOOK

The authors are Dr. J. H. Dellinger, Chief of the United States Radio Laboratory, and L. E. Whittemore, Alternate Chief. The text has been officially approved by the Bureau of Standards to insure absolute accuracy. Lefax knows all—tells how! Technically correct in everyday language. Lefax never grows old. New developments will be covered as fast as they happen, by new pages, issued free to each user, month by month for one full year.

Use It Yourself—
Sell It to Your Customers

You will want one Lefax Radio Handbook for your own use. You will also find a big sale for other copies to your customers who want to understand radio thoroughly (and they all do!). Turn the time you now waste answering thousands of questions into profits by selling Lefax Radio Handbooks. Tear out the coupon below or write today for the Lefax Broadside and special introductory offer.

LEFAX, INCORPORATED

DEPT. R.

Ninth and Sansom Streets

Philadelphia, Pa.

Lefax, Inc., Dept. R
Ninth and Sansom Streets
Philadelphia, Pa.

Send me by return mail your Broadside for radio dealers, outlining in detail the sales possibilities for Lefax Radio Handbooks, your 13 Million advertising campaign and the profits I can make.

Name

Address

City..... State.....

Send this

Philadelphia Pointers

By W. B. WILKINSON, Jr.

"PRAMCO" PRODUCTS

The Premier Radio Manufacturing Company, of Philadelphia, have recently taken over a new and larger plant at Nineteenth and West Berks streets, where all their future manufacturing will be done. Mr. Rubinson, the owner of the Premier company, is well known in the radio field, and has recently trade-marked the binding-points, switch knobs, switch points and other small accessories which he standardized over a year ago, when there was no standard in the smaller radio parts. All Premier products now bear the trade-mark "Pramco," and Mr. Rubinson, in the plant he has taken over, will devote his personal energies to developing new standard lines in radio parts and sets, to bear the name "Pramco." His new facilities will allow him to produce in larger quantities than he has been able to in his plant on North Second street.

OLD FIRM IN RADIO TRADE

The Eastern Specialty Company, of Philadelphia, manufacturers and designers since 1909 of precise and scientific electrical instruments for use by Central Testing Stations, have employed competent radio engineers to design a line of radio parts that reach the standard the company has followed in the electrical field. Their every effort has been to produce the best radio parts that can be designed. Their variometer is a well-made instrument, scientifically constructed with a minimum of space between rotor and stator that gives wave lengths up to 1,000 meters while still giving free play of the instrument. The wood parts are finished by an expert wood-turner, and the instrument is wound with number 18 silk-covered copper wire, giving a neat appearance as well as maximum efficiency. Other radio parts made by this company are built to the same standards. The "Tesco" trade-mark is doing a lot to bring business to this firm from established electrical houses that have dealt with them during the last decade.

RADIO CO. MOVES

The Radiofone Corporation announces removal to the Twelfth Street Terminal Buildings, 5680 Twelfth street, Detroit, Mich. James L. Weir is the Director of Sales.

SMALL SET MAKES APPEAL

The Boldo Radio and Electric Co., of Philadelphia, are producing a midget crystal set, for which they hold several patents, and which has many points which make it an interesting receiver for the amateur to experiment with. Its size, in a neat composition case, is $3\frac{3}{4}$ inches by 3 inches by $1\frac{1}{4}$ inches. Its weight, without head-phones, is six ounces net. This makes it easily portable and sells it readily to the amateur who already has a larger set.

There are many novel features about this type of receiver that make it distinctive, and yet it is claimed by the makers that one can master the operation of it in a few minutes, with little or no technical knowledge. There are ten different hook-ups of the instrument which can be made by sim-

ple adjustment of contacts which involve no change of wiring. The set can receive any broadcasting that the larger crystal sets can receive, and has a wide range in wave lengths for a crystal set, due to its effective coupling and use of switches in connection of the tuning coils. The set will sell to the experimenter who already has a set, or the new buyer who wishes a novel crystal set at a reasonable price.

Colin B. Kennedy, Inc., is a new Delaware corporation with a capitalization of \$235,000. It is to make electrical measuring instruments.

The United Radio Laboratories, to manufacture apparatus, has been incorporated with a capital of \$100,000.

The Natural Voice Radio Horn Co. has been incorporated by E. M. and E. A. Leet.

STILL THEY COME

A customer in the magazine department of Brentano's, New York's noted bookseller, recently counted more than twenty popular radio magazines in English, French and Spanish.

Announce Plans for Fall Chicago Show

The Chicago Radio Show to be held at the Coliseum October 14th to 22d, is rapidly assuming not only definite proportions but an exposition of unusual interest to the radio trade in general is the promise of the management. The Coliseum being recognized internationally as the center of trade expositions, gives any exhibition held there prominence, it is said, throughout the country.

U. J. Herrmann, the managing director, has opened permanent offices in Suite 549 McCormick Building, and has appointed James F. Kerr manager of the exposition. Many novel features in the arrangement of floor space are being worked out, the promoters say, to make the exposition of equal interest to manufacturers and the public in general. Manufacturers, it is claimed, have the most optimistic view of market conditions bettering themselves during the summer months, as much of the patent litigation will be exhausted, thus leaving the manufacturing field in a more settled and stable condition.

The promoters of the Chicago Radio Show say that it will substantiate its sub-title—"international and annual"—and point for proof to the

receipt of a dispatch from Paris. Wilbur Williams, who has been touring Europe in the interests of the exposition, recently secured a promise from Signor Marconi that he would include the Chicago dates in his calendar, and would undoubtedly be present for an entire day during the exposition period.

Mr. Williams called on Madame Eleanora Duse, the famous Italian tragedienne, at her villa in Venice, and found her an ardent radio enthusiast. She has a gorgeous sun parlor fitted with a powerful receiving instrument, enabling her to enjoy operatic entertainment rendered by the La Scala Singers.

Mr. Williams also reports that the foreign manufacturers are keenly interested in the rapid development of the American radio market, and will return to America with an interesting list of prospective exhibitors. The foreign consuls located in Chicago are said to be showing a keen interest in the forthcoming event, especially those of Great Britain, France, Italy and Switzerland, and it is expected that the manufacturers of these countries will have an important representation of their products.

INDOOR AERIAL AMPLIFIES RADIO

Grasping the fact that the electric wires stretching from house to house or from street to street are ideal aeri-als, the Dubilier Condenser and Radio Corporation have developed an indoor aerial socket, called the "Dubilier Ducon," which makes every electric socket in every home a potential radio aerial.

This does away with the construction of expensive, outdoor aeri-als. It is simply screwed into the socket most convenient to use and nearest the radio set. Although it is thus connected with the lighting circuit, the Ducon can be handled without shock. It seems electrically dead, and dead it is to the ordinary house current. Its terminals may be connected by a wire without the slightest danger and without causing a short circuit. All that is required after screwing the Ducon into the electric socket is that it be connected with the receiving set, after the usual connections have been made.

It is claimed that the use of the Ducon eliminates "static," since it cannot reach the lighting wires. The indoor aerial used in connection with an outside series of wires, is said to double and even triple the strength of the signals. With the Ducon, the radio receiver may be carried into every room of the house from cellar to attic. It thus amplifies the number of potential radio users, for it opens the way for radio in such apartment houses, where the construction of outside aeri-als is forbidden or impracticable. It may also be used in summer cottages without any elaborate preparation. The list price is \$1.50 each.

A CRYSTAL SPECIALTY

The Diamant Tool and Manufacturing Company, Incorporated, are making a crystal detector, the special feature of which is a universal adjustment which permits the whole face of the galena crystal to be searched for sensitive spots. The list price is 75 cents, which does not include the crystal.

The company also makes a variable condenser with aluminum plates, affording delicate adjustments at low capacities. This result is achieved through the shape of the movable parts which are specially curved. Double end bearing of movable plates and lock nut on substantial spindle maintain constant and exact spacing between fixed and movable plates, preventing short circuiting.

Immediate Delivery

**Variometers
Vario-Couplers
Panel Mounted
and
Unmounted**



**Vacuum Tube
Detector
and
Amplifier
Panels**

DEALERS—Simplex Products Move Fast
JOBBERs—Place Your Orders at Once

SIMPLEX RADIO CO.

1013-15 Ridge Avenue Philadelphia, Pa.

"EURACO" MICA GRID CONDENSERS

Price 60 cents
(Designed to fit Standard Grid Leak Base)



"Euraco" Condensers are composed of Copper Sheet and Best Grade India Ruby Mica, and are entirely Hand Made.

Manufactured in following capacities:

.000025 Mfd—Correct for Myers Radio-Audion RAC-3	
.0001 " —For Special or Experimental Circuits	
.00025 " —Correct for Super-Hetrodyne & UV 201	
.0005 " —Correct for Radiotron UV 200	

Condenser—Leak Mountings

Bakelite Base with Single Mounting	\$.40
Bakelite Base with Double Mounting60
Bakelite Base with Triple Mounting80

SHIP OWNERS RADIO SERVICE COMPANY, DISTRIBUTORS
EUROPEAN RADIO COMPANY
1342 East 22nd St. MANUFACTURERS BROOKLYN, N. Y.
Interesting Proposition to Dealers

RADIO INSTRUMENTS OF PRECISION

DEPENDABLE



LINE

VARIOMETERS
PLATE CONDENSERS

VARIOCOUPERS
AMPLIFYING TRANSFORMERS

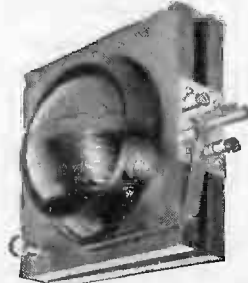

No. 41—PRECISION VARIOMETER

CORRESPONDENCE SOLICITED WITH LEADING HOUSES

THE EASTERN SPECIALTY CO.

3551 N. FIFTH STREET PHILADELPHIA, PA.

**SAYRE-LEVEL
RADIO CO.
Philadelphia**

Distributors
For the Leading Manufacturers
"Everything in Radio"

DEALERS

Send for free samples of our
WINDOW DISPLAY SIGNS
AND CARTOONS featuring
RADIO EQUIPMENT.
THEY ARE REAL RESULT
GETTERS

Merchant's Sign Service
48 Zabriskie St. Jersey City, N. J.



U. S. Eagle Galena

PRICE EACH, 25 CENTS

Marvelous Crystals of Sensitivity; Improve your
Radio Reception by the use of this Crystal. No
better Galena on the American market. Each
Crystal is packed in a tin container, labeled U. S.
Eagle Galena, the galena itself being wrapped in
tin foil and packed in cotton. DEALERS: Write
for our proposition and catalogue, listing all popular
makes of Apparatus.

"If it is anything in Radio, we have it."

U. S. Radio Co. of Penna., Inc.
Manufacturers, Distributors and Importers
Corner Ferry and Diamond Sts.
Pittsburgh, Pa., U. S. A.

Detroit Electric
Company
434 Shelby Street
Detroit, Mich.

Radio
and
Electrical
Equipment

Established 1886

The Fittest Survive

This Is True in Radio Business as
Elsewhere

By THOMAS J. McELROY, Jr.

No other industry has ever felt the rapid growth of success as did the radio business for the dealer and manufacturer as well. No other industry has ever been given the amount of free publicity by newspapers and magazines. The public as a whole became enthusiastic overnight, with the result that scarcely a man, woman or child has not as least seen or heard a radio set in operation. Daily and nightly homes are the center of attraction nowadays with a radio outfit in operation.

But, alas, like any other young industry of promise, radio has its charlatans, too. Many a dollar has been taken by these "fly-by-night" radio manufacturers whose every thought is fraud. Many an owner of a so-called radio outfit has been fooled. These fakers, quite aware of the huge demand for radio apparatus and its acute shortage, have thrown together wires and boxes, slipped a pair of phones into a carton and sold the outfit as being a radio set. This was to be expected and could not be avoided at the start, but now the legitimate manufacturers are protecting the public as well as themselves against any fraudulent schemes on the part of these fakers. As a matter of fact, the press has already begun a campaign against them. One daily newspaper has taken up the fight and is now laboratory testing every piece of apparatus on the market. This newspaper's experienced radio engineers are exposing the frauds. Its columns are blazing forth the news of the tests, giving credit and proof of the good sets and warning the public against the inferior ones.

This is a stand well worthy of commendation and praise. It should be taken up on all sides and pushed to its utmost.

To make it a one hundred per cent success, however, dealers and jobbers of radio apparatus all over the country should fall in line. They should not stock or try to sell any radio set of unknown manufacture. They should stock only trade-marked goods of tried makers. It is a very simple matter to investigate the source from which all radio apparatus comes and great care should be taken before same is stocked. The reward for such an attitude will come to those dealers of course, in the future, for



Real Apparatus
Popular Prices
Good Discounts
Prompt Deliveries
Package Packed

P. E. Edelman, E.E.
Mfr.
9 Church Street
New York, N. Y.

**"ELECTRA"
ANTENNA COPPER CABLE**

We are large manufacturers of seven strand
No. 22, No. 20 and No. 18 stranded Antenna
Wire put up on 5000 ft. spools, 100 ft., 200
ft., 500 ft. and 1000 ft. coils.

Immediate shipments by parcels post, express
or freight.

**"ELECTRA"
LIGHTNING ROD COMPANY**

Manufacturers
30 No. LaSalle St. Chicago, Ill. 212 Market St. Cresco, Iowa

Manufacturers of
GRID CONDENSERS
VARIABLE GRID LEAKS
VERNIER-VARIABLE CON-
DENSERS
PHONE CONDENSERS
FIXED PHONE CONDENSERS
BAKELITE DIALS

BUNTING STAMP CO.
713 Liberty Ave. Pittsburgh, Pa.

Ask For

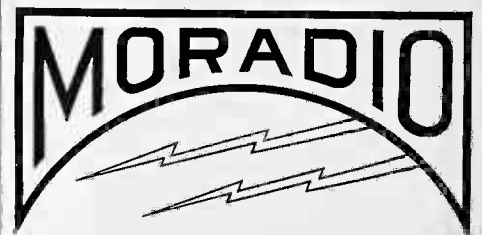

Receiving Sets
Varicouplers
Variometers
Tuning Coils
Detectors
Condensers
Lightning Arresters
and Appliances

Manufactured by
THE MORELAND SALES CORP.
30 Ogden St. Newark, N. J.

it won't be long before all frauds are run out of the radio business.

Another thing for dealers to constantly bear in mind, is not to untruthfully state, whether intentionally or otherwise, that sets will receive over a guaranteed distance. We all know that a guarantee of this kind is not possible, simply because of various local conditions which might enter into the location at which the outfit is to be installed. A certain set may receive twenty-five miles or it may receive twenty-five hundred miles, but to guarantee that it will receive a specific distance is impossible. If dealers would bear this in mind when selling a radio outfit, we would have more well pleased owners of radio outfits. Not alone that but the honest dealer today will be cashing in on the radio sales tomorrow.

ELECTRIC COMPANY TIPS AERIAL ERECTORS

The public spirit of such a public service organization as the Atlantic City Electric Company is illustrated by an advertisement appearing in the Atlantic City newspapers recently. The electric company in this notice gives four rules for the prevention of accidents by radio "fans."

The four rules warn against taking hold of wires hanging in the air or lying on the ground, against hanging wireless aerials over or under any other wires, against attaching aerials to poles used for any other electrical purpose, and against improper fusing in the event of lightning.

Of course these rules are not new. They would apply to the user of the ordinary electric light just as well as to the radio enthusiast. But they are designed to serve such a useful purpose that you, as local dealer, might try to get the electric company in your town to broadcast a similar advertisement in the public prints.

REYNOLDS SPRING CO. HAS BIG DeFOREST ORDER

The Reynolds Spring Co. is said to be working on a large contract for the De Forest Radio Telephone and Telegraph company. This contract, it is said, is for a ten-year period, calling for the delivery of finished products worth \$5,000,000 before January 1, 1923.

In five weeks after signing the contract the Reynolds Spring Co. shipped 2,300 complete radio sets and 5,000 parts. It is also stated that the April profits on this contract totaled \$36,000 net.

NEW RADION HARD RUBBER Panels and Parts

"RADION" We developed "RADION" in our laboratories as all purpose insulation, whose properties make it supreme in the Radio field. Thousands of "RADION" panel sheets are being sold by Dealers daily because men who build Radio sets have learned that—

1. "RADION" resists warping.
2. "RADION" resists enormous voltage in high frequency currents.
3. "RADION" does not chip and is easy to cut, drill, tap, thread, stamp and engrave.
4. "RADION" comes in stock panel sizes 3/16 and 1/4 in. thick, 10 x 12 in., 8 x 15 in. and 20 x 24 in. Three colors—Black, Brown and Mahogany (beautiful mahogany grain).

"RADION" Parts include Dials, Socket Bases, Aerial Insulators, Tubing Rods, Discs, Slider Blocks, Knobs, etc.

DEALERS—Our National Advertising is making thousands of Radio fans ask for RADION Panels and Parts. Don't delay. Write your Jobber today for information and prices.

MANUFACTURERS—Our three great factories are equipped for special moulding of radio parts in large quantities in "RADION" Hard Rubber, such as Radio Cabinets, Ear Caps, Receiver Cases, Y-pieces, Storage Battery Jars and Parts, Knobs, Buttons, Bushings, Ferrules. "RADION" Panels cut to any size on quantity orders. Let us estimate on your specifications.

JOBBERS—We are receiving hundreds of dealer inquiries every week from our National Advertising—many from your own territory—and referring them to Jobbers handling RADION Panels and Parts. Write at once for our jobbing proposition and get the benefits of this National Advertising.

American Hard Rubber Company
11 Mercer Street New York, N.Y.

"PROFCO" RADIO SETS

Are Fast Sellers Because of

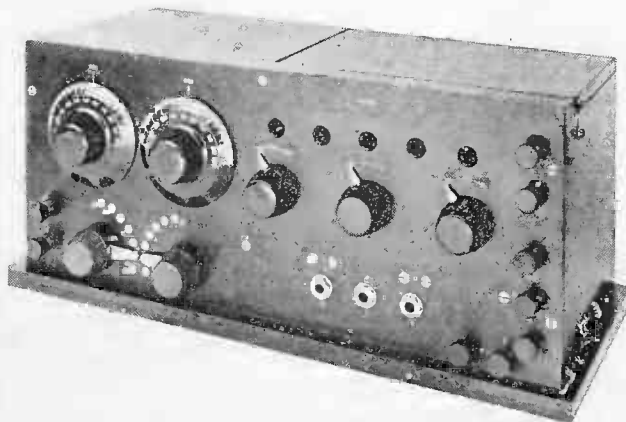

TYPE R-D-2
(Receiver, Detector, and 2 Stage Amplifier)

QUALITY
in Workmanship
NEATNESS
of Appearance
EXCELLENCE
of Design
SIMPLICITY
of Operation

PROMPT SHIPMENTS

\$85.00 LIST

Correspondence Solicited

PROFCO RADIO MFG. CORP.
138 West Broadway, New York, N.Y.

PAPER **TUBES** FOR WIRELESS
 ALL SIZES ON HAND
 FOR IMMEDIATE DELIVERY
 WHOLESALE AND RETAIL
BAEHM PAPER CO., Inc.
 219 Fulton Street New York
 Bet. Church and Greenwich Sts.

COMPLETE SETS
\$1000 up
PETER SPILGER
 West New York, N. J.

Prompt Shipment
 made to Bethlehem, Allentown, Easton, Nazareth, Leighton, Bangor, Catasauqua, Slatington, Coplay, Lansford, Bangor, Emaus, Hellertown and all other points in the Lehigh Valley and United States.
 OUR MOTTO IS "All orders must leave the same day they are received. Satisfaction guaranteed."
 FEDERAL, ACME, DEFOREST, MURDOCK, FADA, PARAGON, GREBE, BRANDES, BALDWIN, RADIO CORPORATION, WESTINGHOUSE, etc. Products carried in STOCK at all times.
 Send us a Trial Order. Catalog mailed postpaid \$1.00 Bell phone 2548J
LEHIGH RADIO CO.
 BETHLEHEM, PA.
 Center & Fairview St. A. F. BREISCH, Gen. Man.

1/8 Automatic Screw Machine Products **2**
MERIT MACHINE MFG. CORP.
 465 Greenwich Street
 New York, N. Y.
 Phone CANal 9128
 9th Ave. L. Desbrosses St. Station

Thornton
 Audio Frequency Amplifying Transformers
Supreme Test Transformer
 These transformers are supplied in either mounted or unmounted types.
Special attention paid to the manufacturer of receiving sets.
Thornton
Transformer Co. Inc.
 30 Church Street
 New York City

ACTIVE CHAMBER OF COMMERCE

The National Radio Chamber of Commerce is negotiating now with the various government departments, such as the Bureau of Standards, Department of Commerce, U. S. Signal Corps, and U. S. Navy Department, with a view to co-operating with these departments in the standardization of radio apparatus, methods of manufacture, methods of testing, etc. It is planned in the very near future to have a central testing laboratory for radio apparatus so that the various members of the National Radio Chamber of Commerce and any other manufacturers interested, may avail themselves of the services of such a laboratory for the purpose of research.

The following is the board of directors of the chamber of commerce: President, Alexander Eisemann, of Freed-Eisemann Radio Corporation; Secretary, Joseph Freed, of Freed-Eisemann Radio Corporation; William Taylor, of Pennie, Davis, Marvin & Edmonds; William Dubilier, of Dubilier Condenser & Radio Corporation; F. A. Andrea, of F. A. Andrea Company; E. Steinberger, Jr., of Electrose Mfg. Co.; C. B. Cooper, of Ship Owners' Radio Service; Leonard Fuller, of Colin B. Kennedy Co.; Jack Binns, Radio editor of the "New York Tribune"; and George Lewis. All requests for information regarding membership, etc., should be addressed to George Lewis, the Membership Secretary, National Radio Chamber of Commerce, 165 Broadway, New York City.

MUSIC MEN DISCUSS RADIO MUSIC

Can music on which there is a copyright be broadcasted for profit unless there is a royalty paid to the composer, or his consent obtained?

That question was propounded at the recent conference of the Music Industries, held at New York, by G. W. Pound, general counsel for the Music Industries Chamber of Commerce.

While the radio, as applied to music, was at first regarded as something of a menace by the musical trades, it is now believed to be an advantage.

The musical folks hold to the opinion that the radio broadcasting folks should pay when using copyrighted music.

ASK OUR SERVICE BUREAU—see advertisement on page 8—it's free. ASK OUR SERVICE BUREAU.

ELECTRICAL TESTING
 of all material entering into Radio Construction. Also Chemical Analyses and Strength Tests.
 Bowling Green 7016
 New York Testing Laboratories
 80 Washington St. New York City

UNCONDITIONALLY Guaranteed for 1 Year
U. S. Storage Batteries
 Supreme for Radio Telephone
A—Batteries
 6 Volts 20 amp. \$7.50
 6 Volts 40 amp. 10.00
 6 Volts 60 amp. 13.75
 6 Volts 80 amp. 17.50
 6 Volts 100 amp. 22.50
B—Batteries
 9 Cell Voltage 22 1/2 V. \$7.50
 20 Cell Voltage 50 V. 13.75
 40 Cell Voltage 100 V. 26.50
 Liberal Discounts—Prompt Deliveries
U. S. STORAGE BATTERY CO.
 P. O. Box 523, FAR ROCKAWAY, N. Y.

A. S. A. RADIO FREQUENCY TRANSFORMER
 Assembled, List.... \$2.75
 Unassembled, List... 1.65
 Type 1.. 160- 500 Meters
 Type 2.. 500-1000 Meters
 Type 3.. 1000-2000 Meters
 Live Dealers Wanted
 Write for Discount Schedule



ARKENBERG AGENCY
 Sole Distributors.
 702 World Bldg., New York

INSIST FOR REPRODUCING
CRYSTAL
 UNCONDITIONALLY GUARANTEED
 'PHONE FIXED
CONDENSER
 LIST PRICE \$.75
 REPRODUCING CRYSTAL
DETECTOR
 IT HEARS THE WEAK SIGNALS
 LIST PRICE \$.90
SWITCH LEVER
 COMPOSITION KNOB—HIGHLY NICKLED
 LIST PRICE \$.40
 IMMEDIATE DELIVERY
 INSIST ON DUGDALE PRODUCTS
DUGDALE LABORATORIES
 55 HALSEY STREET
 NEWARK, N. J.

DELTA ENTERS RADIO FIELD

The Delta Electric Company, Marion, Indiana, long in the electrical accessory field, has now entered into the manufacture of radio equipment, and has put the Delta Gold Stripe Radio-
phone Head Set on the market.

The new head set is very attractive in appearance, is perfectly matched and tuned and is examined for volume before it leaves the Delta plant. Walter B. Stephenson, secretary-treasurer of the company, says that no "fly-by-night" company is behind the product. The manufacturer, whether he be the maker of flashlights, hand lanterns, auto spotlights, and bicycle lamps, or whether he turn his hand to the production of radio sets, is welcome everywhere, as long as he makes an honest product.

RADIO CORPORATION

The Radio Corporation of America is extending its service throughout the United States. According to a latest announcement it is opening a district office at 10 South La Salle Street, Chicago, as well as a warehouse at Unit B, Central Manufacturing Company, in the same city.

This new office is to provide a more central point for distributors and thus offer them convenient facilities for the handling of radio apparatus.

The states to be served by this Chicago office are Alabama, California, Colorado, Illinois, Indiana, Iowa, Kansas, Kentucky, Louisiana, Michigan, Minnesota, Montana, Missouri, Nebraska, Oklahoma, Ohio, Oregon, Tennessee, Utah, Washington and Wisconsin.

GENERAL ITEMS

Albert H. Hawkes, also known as Al. Hawkes, electrician, 1540 Broadway, N. Y. City, filed a petition in bankruptcy, listing liabilities of \$4,168 and no assets except stock of the Al. Hawkes Electrical Specialties, Inc., and accounts amounting to \$1,839.

The Harriman Radio Mfg. Corporation, of Delaware, capital stock \$5,000,000, has designated C. Freshman, 26 West 44th St., N. Y. City, as the New York legal representative.

BAILEY ELECTRIC SUPPLY

A receiver in equity has been appointed for Louis D. Bailey, doing business at 26 Warren Street, New York City, upon application of the E. H. Freeman Electric Co. of Trenton, N. J. It is stated the liabilities are about \$122,000, assets \$192,000.

RADIO DEALERS

We are Jobbers for many manufacturers of high class Radio Apparatus and Supplies

CITY SUPPLY CO.

56 Warren St.

New York City

Tel. Barclay 6613

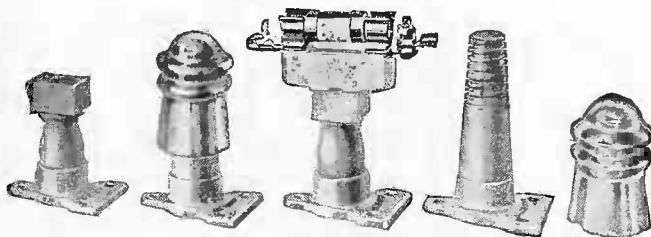

X-RAY INSULATOR ADAPTER

fills a long felt want for a lead in insulator—approved, up-to-date, complies with every regulation, both national and local, made in two styles—one for lead in, one for lightning arrester.

Aeroplane Wire

19 Strand Silicon Bronze Aerial Wire. Each strand (tinned.)

Guaranteed to give 100 per cent satisfaction.

This wire was used during the war by the U. S. Government for aeroplane and trench work and was the only wire to stand up under these conditions.

We have the entire supply and are prepared to make immediate shipments.

Cory Phones 2000 Ohms

Connecticut Phones 3000 Ohms

Turney Phones 3000 Ohms

Liberal Dealers' Proposition

HINTZE BROS., Inc., 459 Central Ave., Newark, N. J.

RADIO DEALERS:

We are Jobbers for many manufacturers of high class Radio Apparatus and supplies, including

DeForest Radio Tel. & Tel. Co. Federal Tel. & Tel. Co.

Western Electric Company Weston Electrical Instr. Co.

General Radio Company Thordarsen Mfg. Co.

King Am-Pli-Tones

We are prepared to co-operate with responsible Dealers in Radio Apparatus and Supplies, and to furnish expert Radio Sales Service.

Correspondence solicited.

EAGAN RADIO SUPPLY SERVICE

Eagan Building

66 Hudson Street

Near Hudson Tube Terminal

HOBOKEN, N. J.

Telephones, Hoboken 105 and 106

RADIO DEALERS

Immediate deliveries, attractive discounts. Dials, headsets, American Beauty receiving sets, variable condensers, transformers, rheostats, vario-couplers, panels, tubes, etc. Standard goods.

Write for Price List of Complete Line
AMERICAN RADIO MFG. CO.
JOBBER, 223 ADMIRAL BLVD.
DEPT. H. KANSAS CITY, MO.

PATENT

your ideas. Protect your rights by U. S. and Foreign Patents and Trade-Marks. Moderate rates. CALL, WRITE or send us your invention.

May one of our representatives call on you?

FREE CONSULTATION
Phone: Vanderbilt 7212.

ASK **MANUFACTURERS PATENT CO.**
FOR **520 FIFTH AVE NEW YORK**

DEALERS

Here's a big money-maker for you

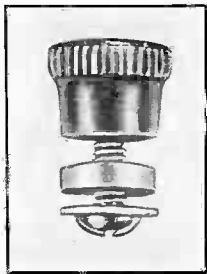

Binding Post

Hard Rubber Top, Standard size
Nicked bases with brass screw and washers, assembled complete.

Natural size

\$5.00 Per List **100**

Write for discounts and samples

Royal Eastern Electrical Supply Co.
116 West 27th St. New York

NERCO (Unitone)

Head Phones
A 2200 OHM Head Set for \$8.00

IMMEDIATE DELIVERIES ASSURED

The Nerco "Unitone" Head Phones are designed to give equal tone reproduction through both phones and to receive sounds sharply and clearly. They are correctly and scientifically built for receiving broadcast programs.

Nerco "Unitone" Head Phones have numerous mechanical features:

They are light, stable and have non-rusting diaphragms. They contain guaranteed tungsten magnets.

IMMEDIATE DELIVERY ASSURED

NEWARK ENGINEERING AND TOOL CO., Inc.

476-482 Eighteenth Ave. Newark, - - - N. J.

If your dealer cannot supply you, order direct from above address.

Chronological Listing of Radio Progress

Step by Step in the History of the Development of Radio

By Raymond F. Yates, Radio Editor of *The Evening Mail, New York City.*
1887

Prof. Hertz proves experimentally that electro-magnetic waves are radiated into space with the speed of light by the electric discharge that takes place between the electrodes of the spark gap of an induction coil or static machine.

1895

Guglielmo Marconi discovers that electrical actions can be transmitted through the earth, air or water by means of high frequency electrical oscillations.

1896

Marconi proves that telegraph signals can be sent and received by means of Hertzian waves up to distances of several miles.

1901

Marconi succeeds in bridging the Atlantic from Poldhu, Cornwall, England, to St. John's, Newfoundland, by sending the historical series of the letter "S," the distance covered being 1,800 miles.

1902

Wireless telegraphy is adopted on large transatlantic passenger vessels, one of the first vessels to be equipped being the American S. S. Philadelphia.

1908

Marconi transatlantic radio stations are opened to the general public for the transmission and reception of radiograms between Great Britain and Canada.

1912

The international radio telegraphic conference approves regulations to secure uniformity of practice in radio services.

1914

Laws are formulated by foremost maritime nations requiring that vessels of certain size and grades carry suitable wireless equipment and operators.

1914

(September 24)

The Marconi Wireless Telegraph Company of America (now the Radio Corporation of America) inaugurates a new American transoceanic wireless service by opening its California-to-Honolulu circuit.

1915

The American Telephone and Telegraph Company, working in conjunction with the Western Electric Company, succeeds in telephoning by radio from Washington to Paris, a distance of 3,700 miles, and from Washington to Hawaii, a distance of 5,000 miles.

1916

President Wilson and the Mikado exchange radiograms at the opening of the new established transpacific radio service between the United States and Japan on November 5.

1919

The Radio Corporation of America is formed, taking over the interests of the former Marconi Wireless Telegraph Company of America and the radio activities of the General Electric Company, and plans for world-wide wireless take form at once.

1920

(March 1)

American government returns high-power radio stations, employed throughout the war, to the Radio Corporation.

AIRPHONE

RECEIVING SETS

Long discounts to dealers

AIRPHONE JUNIOR
Crystal set requiring very little adjusting\$13.50

AIRPHONE MASTER SET
Reported range 700 miles 55.00

AIRPHONE MASTER SET
With two step amplifier..... 85.00

AIRFONOLA
The Wireless Phonograph in period design cabinet.....250.00

Write for descriptive circular

LAURENCE RADIO-LECTRIC CO.
854 Locust St. Cincinnati, Ohio

RADIO BOXES AND CABINETS

Send us your specification and let us figure on your requirements.

PROMPT DELIVERIES.

THE WEIS MFG. CO.
Monroe, Mich.

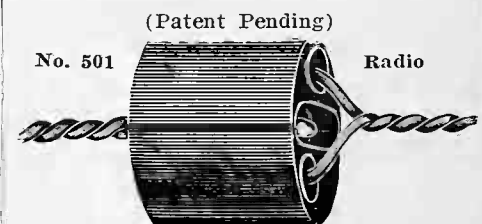

(Patent Pending)

No. 501

Radio

USE OUR NEW

Strain Insulator

—FOR—

WIRELESS INSTALLATION

Equally easy for amateur or electrician to assemble

Perfect Circuit Breaker

Standard Package about 2,000 pieces. Weight 410 lbs.

This Insulator can be used to advantage in any place where a small circuit breaker is used, or required.

Manufactured by

The American Porcelain Company
EAST LIVERPOOL, OHIO

who are also manufacturers of other lines of high grade electrical porcelain.

WRITE FOR PARTICULARS

Radio Corporation resumes commercial operation of its United States to Hawaii-Japan circuit and inaugurates a new United States to Great Britain circuit. Successive additional circuits are then opened with Norway (May 16, 1920), with Germany (August 1, 1920) and with France (January 14, 1921).

An American built and controlled station, to be known as Radio Central, is conceived with facilities for simultaneous wireless telegraph communication to the entire world. To this end, a tract of land covering ten square miles is acquired on the northeastern end of Long Island and construction work begins immediately.

1921

(November 5)

President Harding formally opens Radio Central by sending a message to the peoples of the nations scattered throughout the civilized globe.

UNIQUE CONDENSER DUBILIER'S LATEST

A unique condenser is offered by the Dubilier Condenser & Radio Corporation, in what they call their "Dubilier Micadon." It is a square-shaped series of elements of alternating mica and a special compound, compressed together and impregnated by a special patented process. Each "Micadon" looks like a square biscuit.

The special quality of this unique condenser is that its capacity is constant; that is, there is no fluctuation in the condenser's ability to retain the charge. Howling and whistling noises caused by the dilation and contraction of condenser plates are eliminated. The Micadon is also moisture-proof, thus preventing any impairment of electrical efficiency.

The Dubilier company makes Micadons in sizes ranging from .0001 microfarad capacity to .0025 mfd. The list prices range from 35 cents to 40. Eyelet terminals allow as many as is desired to be joined together to obtain the farad capacity required. The Micadons may also be used as adjusted grid-leaks by sandpapering the surface between the terminals and by making a leakage path across the roughened surface between the terminals with a lead pencil.

NEW DE FOREST SETS

New De Forest sets of greater range, and beauty, are now being designed for early production, according to R. M. Keator, General Sales Manager of the De Forest Radio Telephone and Telegraph Company.

The new sets will include a tuner, a radio-frequency amplifier, a detector, and also an audio-frequency amplifier.

The new line of apparatus, is being designed to satisfy the eye as well as the ear. It will come in period cabinet furniture from \$50 to \$1,000.



Jobbers Attention THE FAMOUS CYCLONE

The World's Best B Battery
Each and Every One Guaranteed
STANDARD EVERYWHERE

Standard Electric Novelty Co.
324-8 Lafayette St. N. Y. City

HAYNES Precision Variable Condenser

The Condenser With a Three-fold Appeal

- (1) It appeals to the Radio engineer or semi-technical amateur because of its extremely high power factor in the oscillating circuit. He knows this means louder signals and freedom from interference.
- (2) It appeals to the mechanical man as being mechanically perfect; he appreciates the equal distribution of weight on the single large brass bearing, and the resulting free and smooth motion (counter-balanced on dial side of bearing). He also realizes that the perfect plate alignment could only have been obtained by hydraulically pressing the spacing washers to the smallest fractional uniform thickness.

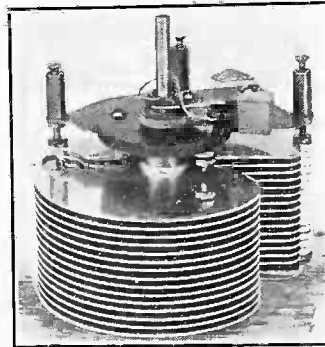

- (3) Lastly, it appeals to "Mr. Average Radiophone Enthusiast" as being a good looking condenser at a fair and reasonable price, and one entirely worthy of a place in his new set.

Haynes Precision Condensers

are furnished in the following capacities, unmounted only, but including counterbalance:

.0011 mfd.	-	\$5.75
.0005 mfd.	-	4.75
.00025 mfd.	-	3.90

Distributors: Our policy is to sell only thru exclusive distributors where possible. We would be glad to send you our discount schedule and consider your proposition.

Haynes Radio Co., Inc.

(FORMERLY THE HAYNES RADIO SHOP)

629A Lexington Ave. (at 54th) Phone, Plaza 6301 New York, N. Y.

RADIO PANELS

And other insulation for Wireless Work

BAKELITE-DILECTO

Grade XX Black was used by the Government during the war for this purpose. It is the

Standard of the World

THE CONTINENTAL FIBRE COMPANY

NEWARK, DEL.

New York, 233 Broadway
Pittsburgh, 301 Fifth Ave.
Los Angeles, 411 S. Main St.
Seattle, Wash., 1927 First Ave., South

Chicago, 332 S. Michigan Ave.
San Francisco, 75 Fremont St.
Rochester, N. Y., 85 Plymouth Ave., South

KUBEN CABINETS

The best on the market. We make them in any size and any quantity.
MANUFACTURERS: We solicit your requirements.
JOBBER AND DEALERS: Write for price or stock sizes.
KUND & EIBEN MFG. CO.
204-224 Warrington Ave., Pittsburgh, Pa.

PATENTS

on radio inventions apply to
OTTO K. ZWINGENBERGER
38 Park Row, New York
Cortlandt 3207

Boldo Radio Receiver

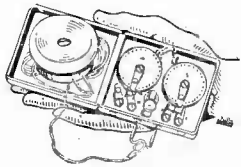

Is a high efficiency pocket wireless receiver, not a toy, but a practical Radio instrument. With ten hook-ups.
Dimensions: 3 3/4" x 3" x 1 1/4".

Weight: 6 oz. Retail price, \$15 without phones.

BOLDO RADIO & ELECTRIC CO.
30 North Fifth St., Philadelphia, Pa.
Dealers and Jobbers write for territory and discounts.

SEND FOR OUR PRICE LIST

We are manufacturers of
SLIDERS
Threaded Brass Roding
Crystal Cups
Headless Brass Screws

Niglo Associates
Box 15, Millvale P. O.
Millvale, Penna.

GANAERITE
Detector Crystals

Twenty years of practical mineralogy gave us the material to produce the highest quality crystal.

We are now undertaking the largest single order for mounted crystals in the market.

We individually test and guarantee to replace or refund on any unsatisfactory Ganaerite crystal.

The Harris Laboratory
26 Cortlandt St., New York City

STATIC

(Continued from page 23)

stallation instructions. They have spent many dollars in advertisements telling the public that it required no previous experience to successfully operate their receivers and then made up and sold receivers that required a "crack" operator to handle.

I believe that the construction and operation of radio apparatus requires an even greater understanding of the principles involved than running a car and that without this knowledge radio cannot be successfully introduced into the home life of the general public, but will suffer the fate one associates with "fads" and after a brief popularity will be cast aside.

This must not happen. Radio is not a "fad." We who have spent a number of years in radio know that it has a place in the life of the public no less important than the telephone, the phonograph or the motor car. It is destined to become the greatest means for the dissemination of information, education, and wholesome entertainment to a wide spread audience and we can either hasten or impede the fulfilment of this destiny by our actions and attitude during the next few months.

Let us forget all about "static," let the public enjoy their automobiles and the healthful recreation of out-door life if they want to, and in the meanwhile we must prepare ourselves and our salespeople to begin next September if not before, and intelligently sell radio to the public and keep it sold!

NEW FIRM AT WORK

The Central Radio Laboratories have recently been incorporated under the laws of the state of Wisconsin for the purpose of developing and manufacturing parts for radio equipment. The new company, whose office and manufacturing plant are located at 303 Sixteenth Street, Milwaukee, has already established production on one of its initial products, a filament rheostat, at the rate of one thousand per day.

The president of the company, E. R. Stoekle, Ph. D., has resigned as physicist of The Cutler-Hammer Mfg. Co. in order to assume active charge of the business. Mr. Stoekle was formerly associated with the Western Electric Laboratories on research and development work in connection with vacuum tubes for radio telephony. He was also connected with the Physics Department of the University of Wisconsin at one time. C. R. Hammond is the sales manager of the company.

TUNING COILS

Cross Weave Tuning Coils the heart of a receiving set just the coils for bringing in the Radiophone Broadcasting stations 180-500 Meters. Price \$1.25 each, or set of three coils Primary, Secondary and Ticker Coils, \$3.50 per set with circuit diagram.

CONDENSERS

Phone and Grid built of the best material obtainable. Price \$1.00 each.

MOTOR-GENERATOR SET

250 Volt DC 175 Watt Generator and 110 Volt AC 60 Cycle (Any Cycle) Motor. The best there is. Price \$78.00 complete.

AERIPHONE

The wireless telephones. Price \$35.00 to \$300.00.

PANELS

Treated with a special process made by us. Will not Warp or Shrink and is not affected by Temperature changes. Waterproof and possesses High Dielectric properties. Easily machined and will not Crack or BREAK. Looks as good as Bakelite. We are prepared to ship promptly the following sizes:

6" x 6"	x 1/4" thick	\$.60
6" x 7"	x 1/4" thick75
6" x 10 1/2"	x 1/4" thick	1.00
6" x 12"	x 1/4" thick	1.25
9" x 12"	x 1/4" thick	1.50
9" x 14"	x 1/4" thick	1.75
12" x 14"	x 1/4" thick	2.20
12" x 21"	x 1/4" thick	3.00

Strips 3 1/2 x 6; 3 1/2 x 8, \$.40 each; 3 1/2 x 10, 3 1/2 x 12, \$.60 each; 3 1/2 x 18, \$.75 each.

Add postage for 1 lb. for Panels up to 6 x 12 x 1/4; and 2 lbs. for larger sizes.

We will be pleased to quote prices on these panels cut to a different size on receipt of your specifications. NO FREE SAMPLES.

NATIONAL RADIO CO.
MARSHALL, MINN.

M-P-M



FLASH



M-P-M

Across the Ocean on
M-P-M Mineral

Have you received the latest Hazeltine Hook-up? If not, don't delay, send today. \$1.00 brings it to you with a free sample of M-P-M.

DEALERS—WRITE FOR PROPOSITION

MILLION POINT
MINERAL CO.

Needles, Calif.

Around New York

By En Why See

"Spend a few days and see what's doing in the retail radio shops in New York." This was the terse command of my editor and with these words ringing in my ears I cranked up my flier and started. I tossed up a coin and started in the Harlem section of New York. I surely thought I would have a real joy ride, because I thought it would be a long ride between shops. I soon found out my mistake because I found that almost every corner that formerly harbored a saloon (for the information of our readers—a saloon was a place where beverages containing more than four per cent of the unmentioned a ***hol.) now contained a radio store.

All of these stores are well fitted up, and seem to be well patronized. Most of the best customers are young men in their 'teens. At night these stores are crowded by the mothers and fathers of these boys. Amusing incidents can be cited how Bill or Jim explains the mysteries of the radio to his parents. Mother and father simply look at their young hopefuls and with knowing nods, seem to grasp the radio talk. Before the sale is made a conference is held and then money changes hands. "Jim" or "Bill" walks out with his bundle and his face is all lit up with smiles.

It is not my purpose to criticize, but if I were running a retail store I would use an indoor antenna. Most folks are against radio because the installation of a set leads them to believe that a roof antenna must be used. The principal reason for this antipathy is that "Ma" and "Pop" are afraid of having their offspring bounce to the street.

Every retailer complains that his whole day is taken up by salesmen who have nothing new in the radio field. Some of these salesmen represent well known firms while others represents mushroom concerns which are springing up at the rate of one a second. Very few salesmen are offering the "real-hard-to-get" accessories. A few are offering "bootleg" tubes but they are not finding many takers.

Some of the shops are also selling homemade sets, and they are going fast. All kinds of books on radio hook-ups sell as fast as they are received.

Among the real honest to goodness radio stores in Harlem is Klein's at 1

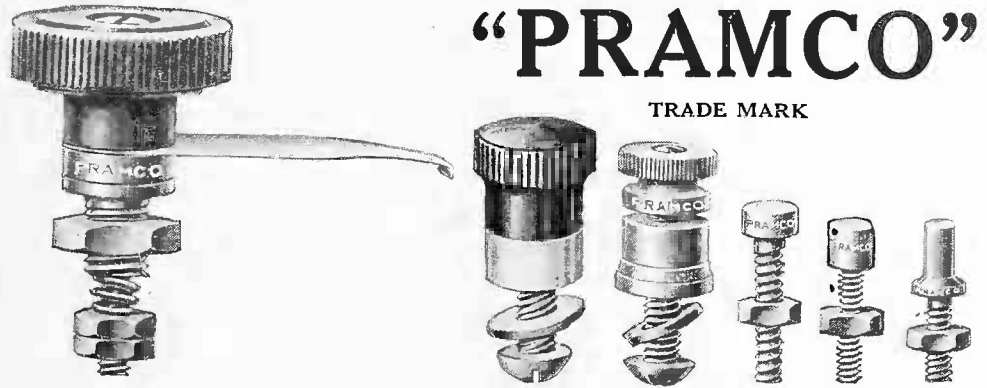

Not merely a SWITCH POINT or BINDING POST, but the BEST. A superiority of workmanship and finish that eliminates all quality competition.

Assure your future business now. Articles with the name "PRAMCO" stamped on them need no apology.

PREMIER RADIO MFG. CO.

1900 No. 6th St.

Philadelphia, Pa.

Switch Points, Binding Posts, Crystal Cups, Detector Posts, Switch Levers, Etc.

Dealers and Jobbers get our quotations

MR. RADIO RETAILER!

You NEED This Paper. Do you think it will be worth a dollar to get THE RADIO DEALER every month for the next year? Use the blank below, rubber stamp or print your name and address, then mail to us. Do it today.

HARRY M. KONWISER, *Publisher,*
The Radio Dealer,
 1133 Broadway,
 New York City.

Please send THE RADIO DEALER to the following address for one year

for which { we enclose one dollar
 { we will send one dollar on receipt of bill.

(Name)

(Address)

(City and State)

Make remittance by check, money order or registered mail

CAP SCREW AND NUT CO.
OF AMERICA
318 West 47th Street New York
Manufacturers of Screws, Bolts, and
Nuts of Every Description
BRASS NUTS IN STOCK
Immediate Delivery. Write Dept. A

SHIPPED FROM STOCK

*Prices Net to
Dealers Only*

Variometer, complete high
grade 2.25
Variometer Parts, includes all
necessary parts except
wire 1.00
Variocoupler,
complete 1.75
Variocoupler Parts, complete set,
of parts. No wire is in-
cluded85
Thordarson Amplifying
Transformer 2.80

Mail Orders Promptly Filled

Scientific Dealers Supply Co.
2727 Fullerton Ave.
Chicago, Ill.

**It pays to ad-
vertise—ask
our adver-
tisers.**

If you have some-
thing to sell the
Radio Trade, fill in
the blank below—
an ad this size would
only cost \$18.60
per issue on contract

ADVERTISING ORDER

HARRY M. KONWISER, Publisher,
THE RADIO DEALER,
1133 Broadway, New York City.

You may insert our advertisement,
copy attached, in the next 12 issues of
the RADIO DEALER, to occupy space
of six inches, for which we agree to
pay you at the rate of \$18.60 per issue.

(Signed)

(Address)

(City and State).....

Minimum order, four inches

West 125th Street and Coes', at 15
West 125th Street. Friend Coe men-
tioned to the writer that in all of his
retail experience—he has had over
twenty years of it and all in one spot
—he never saw anything spread as
rapidly as radio. His store is one of
the busiest places in Harlem, and
Harlemites believe in him. Quite a
few so-called radio stores on the
"shlock" type are not more than a
hundred miles from 125th Street.
These stores carry a limited supply of
radio equipment—most of which is of
unknown manufacture. Some of
these boys were formerly in every line
of business—and simply stay in a new
line for a short while and as soon as
they find out that they cannot clean up
in a chosen field—they leave it. Need-
less to say no one will miss their de-
parture from this field.

Yonkers, New York, has over
twenty radio shops. I visited every-
one of them, and got a cash paid sub-
scription in almost everyone of them.
I told everyone of them where to buy
something that he asked me about. A
couple wanted to join the new associ-
ation which is being organized by the
RADIO DEALER. I showed one how to
rig up a tube set and spoiled a per-
fectly good pair of pants taking down
an out-door antenna and replacing it
with an indoor antenna.

THEATRE IN THE HOME

"Properly made and installed, the radio
in reality becomes 'The Theatre of the
Home,'" so Harry Botsford, publicity man-
ager of the Lyradion Sales and Engineer-
ing Company of Mishawaka, Ind., states
in an interview. "But it must be installed
in a cabinet which will take up a mini-
mum amount of space, and it must be
equipped with an amplifying horn that will
be powered to fill a room of large size.
Given these qualities, radio will do more
to popularize good music than anything
else in the world. Music dealers should
profit exceedingly, as people will hear a
selection by radio and will wish to make
that selection permanent in their home by
the purchase of it in phonograph record
form, in player roll or sheet music."

If you buy from your neighborhood
radio shop and don't get satisfactory
parts you can kick and the right sort
of a retailer will make amends. We're
for the right sort of retailers!

Beginners should understand (and
should be told) there is no definite way
in which anyone can tell them how
far they can receive. At best it is all
guess work. The reason for this is
that there are many conditions to be
taken into account which differ with
each individual case.

VACUUM TUBE DETECTOR \$5.50

Including complete cabinet with all instruments
wired ready for use.



**DETECTOR AND
TWO STAGE AM-
PLIFIER \$22.50**

With transformers and
all other instruments in
cabinet, ready for oper-
ation. This equipment
is of high quality, and
distances of as high as
3000 miles have been
obtained with ease.

**BATTERIES AND
TUBES EXTRA**

2000 Ohm receivers \$5.00

SUPERIOR CRYSTAL RECEIVING SET \$4.75

Attractive dealers proposition

STEINMETZ WIRELESS MFG. CO.

5706 Penn Ave.

Pittsburgh, Pa.

CORONA SR.

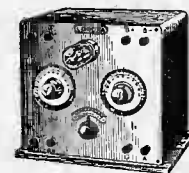

Price \$30

Attractive discounts in quantities

A Dependable Vacuum Tube

Receiving Set

Immediate Deliveries

**CORONA ELECTRIC
CORPORATION**

Radio Division

265-7 CANAL STREET, New York

Telephone: Canal 0015

"COPPERWELD"
TRADE MARK REG. U.S. PAT. OFF.

ANTENNA WIRE

50% Stronger Than
Copper

Better than Solid Copper
or Strands

Less Sagging and
Stretching

Adopted by Largest Radio Corporations

Buy it in Cartons

At All Dealers and Jobbers

100-Ft. Cartons

150-Ft. Cartons

200-Ft. Cartons

Copper Clad Steel Co.

Radio Dept. Braddock, P. O.

Rankin, Pa.

WHAT BOSTON IS DOING

The Radio Equipment Co., which claims to be the oldest exclusive house in New England, is about to put on the market a safety fuse to sell four for a dollar, the only device at present, it is said, that absolutely prevents the burning out of Vacuum Tubes.

Beaudette and Graham, one of Boston's well known electrical appliance houses, are moving into new quarters at 915 Boylston St. about the first of July.

It is rumored that the Tower Mfg. Co., are working on an order from S. S. Kresge for 100,000 head receivers, 3,000 ohms, weight around 6¾ ounces. Kresge's is a well-known 10, 15 and 25 cent store.

The Viking Radio Co., are making a three plate Vernier condenser to sell for \$1.50. This was awarded the Certificate of Excellence by the New York "Mail."

Mr. Lewis of the Lewis Electrical Supply Co., says that one of the reasons that business is not as good as expected with the retailer is that many possible buyers have formed the impression that there are going to be some radical changes in receiving sets. Many of them have also expressed the thought that prices of sets and parts would be lower. Mr. Lewis thinks that the larger manufacturers would do well to advise the public to the contrary.

NEW GREBE FACTORY

A. H. Grebe & Co. are about to commence work upon their new factory at Richmond Hill, Long Island, and as this factory is to be of Barney-Ahlers construction it will be the "last word" in factories and will be the finest built radio plant in the world. Eugene H. Klaber is the consulting architect.

CONVERTS VICTROLA

A device by which any Victrola, or hornless phonograph, may be transformed into a loud speaker, is offered by the Precel Radio Manufacturing Co. This instrument, which couples any radio telephone ear-piece to the tone arm of the Victrola, is known as the Victrola adapter. It is of cast aluminum, machined and highly polished. It can be attached to the phonograph in a few seconds. By this device the clear tone chamber of the average talking-machine is utilized as a perfect loud speaker. The list price is \$1.50.

The Precel Radio Manufacturing Co. also makes a general line of detectors, binding posts, switches, rheostats, sockets, condensers suitable for the average audion set, and the sets themselves.

**Manufacturers!
RADIO PANELS**

**of Genuine
BAKELITE-DILECTO
XX Grade Black (Polished Surface)**

Cut accurately (sharp edge) to your specifications

OUR SERVICE IS COMPLETE.

We are Specialists in DRILLING, ENGRAVING, GRAINING

Immediate Delivery

Bakelite-Dilecto was used *exclusively* during the War by all departments of the United States Government, Navy Department, War Department and Signal Corps—No other material would meet their exacting requirements.

If our Government relied upon Bakelite-Dilecto during the stress of War for Wireless Insulation, you and your customers can safely depend upon it in time of Peace.

Made Up Samples on Request

STANDARD RADIO PARTS CO.

30 Church Street, Room 2013

New York, N. Y.

Phone Cortland 6788

**KEYSTONE RADIO
LIGHTNING ARRESTERS**

Approved by Underwriters

You can sell hundreds of Keystone Radio Arresters. Every Receiving Set must be protected with one of these lightning arresters which are approved by the Underwriters. Don't overlook this opportunity to make quick profits.

You should standardize on the Keystone Arrester for these reasons—Small in size, weatherproof, entirely enclosed and sealed, foolproof, constructed by a Company having 30 years' experience in lightning arrester design, low capacity and high resistance, no carbon plates to disintegrate and short-circuit gap, no fuses to blow nor vacuum to lose and so reduce the efficiency of the arrester to a point where it is practically valueless.

Write for Prices and Circulars

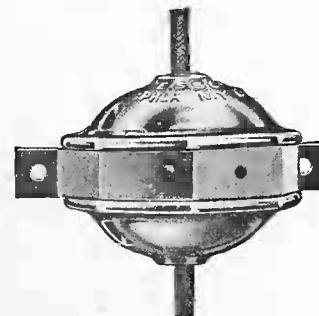

Type A, Keystone Arrester
Price \$2.00



Type B, Keystone Arrester
Price \$2.00

SIMPLEX

- Variometers
- Vario-couplers
- Detector Panels
- Amplifier Panels
- Rheostats



Write for New Circular and Dealer Prices

ELECTRIC SERVICE SUPPLIES Co.

Mfrs. of Lightning Arresters for 30 Years

PHILADELPHIA
17th and Cambria Streets

NEW YORK
50 Church Street

CHICAGO
Monadnock Building

Distributors for Simplex Radio Company

100% Radio

Altadena Radio Laboratory

562 E. Colorado Street

(After July 1)

Pasadena, Calif.

Jobbers of All Standard Radio Apparatus, including

A-P Tubes
Acme Apparatus
Baldwin Fones
Blank Radio Call Books
Burgess Batteries
Cunningham Tubes
Edison Storage Batteries
Emerson Fones
Federal Apparatus
General Radio Apparatus
Jewell Meters
Kennedy Equipment
Magnavox Equipment
Paragon Receivers
Radio Corporation Apparatus
Thordarson Transformers
Western Electric Fones
Weston Meters

PAUL FRANKLIN JOHNSON

A NEW BOOK FOR EXPERIMENTERS!

ELEMENTARY TEXT-BOOK ON WIRELESS VACUUM TUBES

3rd Edition

by

JOHN SCOTT-TAGGART

Member of the American Institute of Electrical Engineers

WRITTEN EXPRESSLY FOR THE AMERICAN AMATEUR

230 Pages. 130 real practical circuits.
The best book on C. W. and Telephony.
Handsomely bound in blue art vellum.

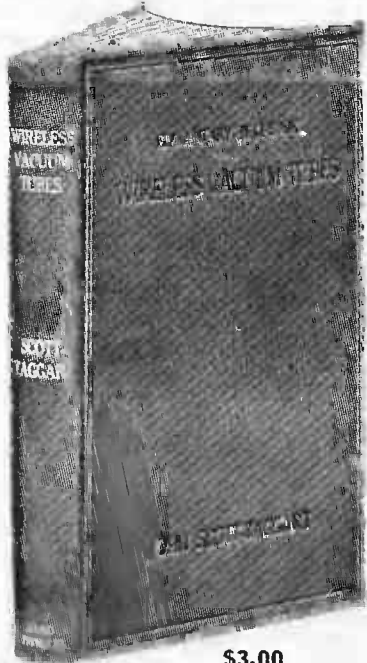

\$3.00

Extraordinary Sales

Dealers are invited to send orders for 12 or more copies on special terms.

JOHN FIRTH COMPANY, 709 Sixth Ave., N. Y.

S. A. TUBE SOCKETS

The Type SA, Vacuum Tube Socket, manufactured by The Radio Electric Company, represents the last word in tube receptacle construction. Electrically, it features extremely low capacity losses and a minimum of energy leakage.

The receptacle shell is made of high-grade brass sheet 3/64 inch thick, and will not chip or crack under the most strenuous use. The base measures 2 1/4 inches by 2 7/8 inches by 3/8 inches thick, and is made of a special heat-proof moulded composition of very high insulating qualities. The contact springs are made of the very best Phosphor Bronze sheet possible, and have large rounded end contacts. These contact springs are set 1/8 inch off the table or mounting shelf, thus eliminating all possible chance of accidental short circuiting.

The receptacle may be back-mounted by reversing the connecting screws, or the shell itself may be removed, and used on a supporting panel, where more than one socket is required. The contacts are marked with suitable engraving, and all metal parts have a high nickle polish, making the unit most attractive.

This company also manufactures a very high grade inductance switch, known as the Type S. C. This switch is of the most improved type and possesses many attractive features. The knob of moulded composition is of the tapered design. The contact arm, with a radius of 1 3/8 inches, is of laminated Phosphor Bronze, and so designed as to afford clean and sure contact at all times. The shaft is securely attached to the knob and made to revolve inside of a threaded bushing, which affords considerable bearing surface and eliminates rocking. A special brass lug is provided for making connections. All metal parts have a high polished nickle finish, making the switch a most attractive unit.

NEW AJAX RHEOSTAT

A rheostat, with a base of aluminum to prevent warping, with resistance wire wound on asbestos to eliminate the burning of insulation and with unusually large contact surface between the resistance wire and the switch blade is made by the Ajax Electric Company of Cambridge, Mass. The name of the new instrument is the Ajax All Vernier Rheostat. The switch blade can be rotated over the entire length of the resistance wire allowing Vernier control at any point. The two amperes, seven Ohms style is listed at \$1.75, and the 4 amperes, 7 ohms at \$2.00.

MAILING LISTS

500 Radio Dealers, \$5.00
Dealers in New York and surrounding territory.
365 Radio Jobbers, \$5.00
Jobbers with A-1 credits throughout the country.
Lists neatly printed. Send cash with order. Postpaid.
RADIO HANDBOOK PUBLISHING CO.
9th and Sansom Sts., Philadelphia, Pa.

Telephones: 5454 Beekman 2787

NAME PLATE COMPANY

ETCHED OR LITHOGRAPHED METAL

NAME PLATES, SIGNS, DIALS

125 FULTON ST., NEW YORK

**Attention
Radio Dealers
and Jobbers**

40 and 10

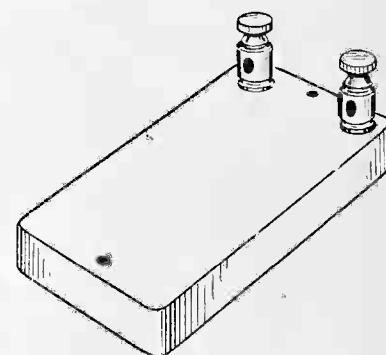

Serco Fixed Condensers,
moulded, 70 cents

Serco Fixed Condensers,
moulded, 90 cents

Serco Crystal Detector, \$1.25

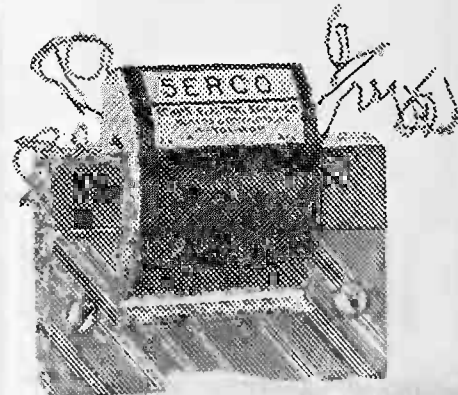

Serco A.
former, 10 to 1 ratio, \$3.50

We are Manufacturers
of
Serco Radio Products

Write us about that special 40 and 10

Scheib Elec. Radio Co.
6243 Station Street
Pittsburgh, Pa.

Got a Tapper Key?

That's a Telegraph Key in Britishese

"Vacuum tubes" are known as "radio valves."

"Tuning coil" is known as "inductance coil."

"Binding posts" are "terminals."

"Amplifier transformers" are "intervalve transformers."

"Vacuum tube sockets" are "valve holders."

"Telegraph keys" are "tapper keys."

"Contacts for switches" are referred to as "contact studs."

"Hard Rubber" is "ebonite."

"Condenser plates" are "condenser vanes."

There are no "radio amateurs" in that dear England—they're known as "amateur wireless enthusiasts."

Ask Our Service Bureau

NOVO "B" Batteries



for Radio Outfits

NOISELESS—DEPENDABLE—GUARANTEED

All Sizes—Plain and Variable

22½, 45 and 105 Volts

Send for Catalogue and Discounts

NOVO MANUFACTURING CO.

424 W. 33rd St.
NEW YORK

531 So. Dearborn St.
CHICAGO

GLOBE RADIO HEAD PHONES

*"East and West
The Globe is best"*

Light Weight (only 11 oz.)

Can be worn for hours

with utmost comfort.

Specially designed

Headband and

easily adjusted.

2200 ohms



Highly Sensitive

Balanced Receivers

Natural in Tone

Each Receiver

Tested Wirelessly

List \$9.00

The GLOBE PHONES were designed to meet the demand for a strictly high-grade telephone headset at a popular price. The reception of speeches, sermons, musical concerts and messages requires the use of sensitive phones. All these points were taken into consideration in our design.

The GLOBE PHONES are perfect in articulation and they will stand amplification without distortion. Our knowledge of acoustics based on nearly fifteen years of experience in making high-grade sound-producing and receiving instruments has been of great value to us in the development of the GLOBE RADIO HEAD PHONES, enabling us to produce phones of a very high standard of efficiency. The Globe name is our guarantee of high quality.

distributors of the GLOBE VACTUPHONE, invention of Earl C. Hanson, the only hearing device made for vacuum tube amplifier.

DEALERS! If your jobber cannot supply you with GLOBE Head Phones, write us giving us his name.

SOMETHING NEW

For use in apartment houses, homes, etc.

Use the electric light wire for your antenna. The Globe Antenna Attachment Plug allows you to connect your Radio receiving set in any room. No other wires necessary. Ask for the Globe Plug. Particulars on request.

GLOBE PHONE MFG. CO., Reading, Mass., U. S. A.

Earl C. Hanson, Technical Radio Expert

Manufacturers of RADIO AND ELECTRICAL SPECIALTIES

Phone: Market 1775
AUTOMATIC AND HAND WORK
 Quick Deliveries
 Satisfaction Guaranteed
RELIABLE MACHINE SCREW CO.
 355 Mulberry Street,
 Newark, N. J.

Ask Our Service Bureau



Ray-O-Vac
Long Life B-Battery
for all types of
Radio Sets

Specially built by battery experts for Radio Service. Ray-O-Vac batteries are now ready for delivery.

Fifteen cells are assembled as a solid unit and treated with special insulating compound to eliminate induced current and noises in receiving.

Four sizes: For Stationary Sets with variable voltages from 1½ to 22½ volts; Portable Type with voltage adjustment 18 to 22½ volts; for Airplane Sets, weight only 1 pound, full 22½ volts. Baby B Battery for use in boosting voltage when larger battery has been over-worked.

Write for literature and prices.

FRENCH BATTERY & CARBON CO.
 Madison Wisconsin



French RAY-O-LITES and Dry Batteries

Hit the Sharks!

Watch Out for the Slick Stock Salesman

Broadcasting stations should join in sounding a warning to enthusiasts against promiscuous purchasing of radio stocks. If every broadcasting station would nightly advise their listeners to consult their banker before investing in any radio concern's stock considerable sums of money will possibly be saved the amateur enthusiast.

Reputable business houses selling reputable stocks in radio concerns can have no complaint at this. Bankers are not quick to denounce a concern that is reliable, nor are they prone to recommend valueless stocks to their depositors.

Radio bugs are susceptible to the wiles of the stock salesman if he comes armed with a few radio terms for a starter. The rapidly growing industry offers an opportunity to make money and certainly we will have many more successful companies in the radio business, but not every stock offered for sale with the name radio will bring money and profit to the purchasers of the stock.

A banker's business is money, he is a specialist in that line. In matters of investment it is always wise to consult a specialist.

PARTS OF BAKELITE

The Chelsea Radio Company, who are one of the old time Radio concerns, have continued to maintain the high quality of their line of radio receiving equipment during the recent inflated period. It has been the experience of the personnel of this organization that the material known as composition, or hard rubber substitute, is wholly unfit for Radio, inasmuch as it will not withstand the test of time, is easily broken and in the case of some wax compounds will actually flow when placed in the hot sunshine.

Equipment made of bakelite and condensite is unbreakable, embodies the highest insulation characteristics and cannot be injured even by many hundreds of degrees of heat.

As proof of the high quality of this line it is stated that in the case of the now famous Chelsea Condensers less than one rejection in 20,000 condensers is experienced, and this in the face of a guaranteed operation at 1,000 volts.

This company is issuing their new bulletin No. 6 showing a complete line of its high-grade radio equipment.

A REAL MONEY MAKER AND SALES HELP FOR THE DEALER
Over 100,000 SOLD

THE BEGINNER'S HANDBOOK TELLS HOW TO MAKE YOUR OWN THREE EASY SETS

- 1—Complete Simple Crystal Receiver, good up to 15 miles.
 - 2—Complete Vacuum Tube Receiver, good up to 50 miles.
 - 3—Two stage amplifier, good 100 miles up.
- Contains also Beginner's Dictionary, History of Radio, page of Broadcasting Symbols, Easy Method of Learning Telegraphic Code, List of Broadcasting Stations.

ALL IN ONE BOOK for 25c.

Lists all parts necessary to build. Easily understood diagrams.

Write at once for our attractive Sales Plan
E. J. HENDRICKSON COMPANY
 332 East 27th Street
 NEW YORK CITY, N. Y. Dept. A.

ATTENTION MR. DEALER

I am jobbing Radio Specialties such as Phones, Condensers, etc., and clearest vacuum tube detector unit 600 Meter Range, Retail \$35.00. *Write for dealers proposition.*

Raymond De Wyngaert
 91 Walnut St. Newark, N. J.

VARIABLE CONDENSERS

Semi-Circular Type

	LIST
43 Plate	\$3.75
23 Plate	3.25
11 Plate	3.00
3 Plate	1.25

Square Law Type

0015 Mfd	\$6.00
001 Mfd	4.25
00075 Mfd	3.75
0005 Mfd	3.00
3 Plate	1.50

Special Prices on Knocked-down Condensers

Montrose Mfg. Co.
 1200 Bedford Ave., Brooklyn, N. Y.

AMRAD

The Recognized Symbol of Superior Performance

**Something
New
Under
The Sun**

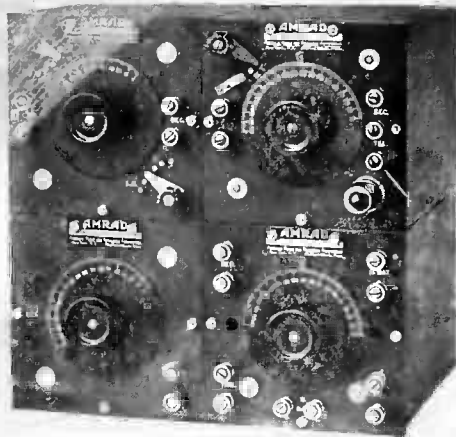

Modern Relay Receiver
(One of 15 combinations)

The Amrad Unit System

Includes a group of complete Receiving Units designed solely for the wireless experimenter to meet his need as he progresses to the topmost pinnacle in Radio.

Called the most practical, convenient, and efficient standardization plan ever developed.

Practical because economical—you need never discard your original apparatus as you improve your station; convenient because each Unit is uniform in design, size and finish—you avoid fussy construction work; efficient because each Unit is designed by commercial Radio experts to give maximum results, and because the final group of Units produces as fine a receiving station as can be desired.

The Amrad Unit System comprises ten complete Receiving Units:—Couplers and Variometers, short and medium wave, (mounted and unmounted); Crystal Receivers; VT Detectors; VT Detector Amplifiers; and VT one and two stage Amplifiers.

To Amrad Quenched Gap Users: Complete set of our new Leak-proof Gaskets sent free upon receipt of your gap type and serial number and 10c postage.

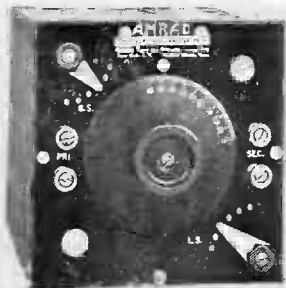

Amrad Coupler
\$17.50



Amrad VT Detector
\$15.00



Amrad VT 2-Stage Amplifier
\$39.50

DEALERS:—The Amrad Unit System meets every demand of the Radio Experimenter from the earliest to the most expert stage. Once an Amrad user, always an Amrad user.

AMERICAN RADIO AND RESEARCH CORPORATION

3 Park Row
New York

Address all Communications
to New York Office.

Factory and
Medford N.J.

CONNECTICUT RADIO



This Amateur "found it far superior"

Read this letter (from Pennsylvania) on the CONNECTICUT Variable Condenser.

"Have been using your unique two plate condenser for several weeks. Have tried it on a number of crystal hook-ups and have found it to be far superior in actions and stability than a ***** condenser which I am also using in my present hook up.

"I have also been able to cut out entirely NAA and other stations with your condenser, while it is impossible with the other.

"I can sincerely say that this instrument for its size and work cannot be equalled. It is also a very fine addition to a Radio Outfit as it not only increases the receiving capacity, but also adds to the fine appearance of many outfits.

"Wishing you the best success with your new condenser I remain,"

Your results can be just as good.
Our booklet tells all about the
new Condenser — Send for it.

CONNECTICUT TELEPHONE & ELECTRIC COMPANY
en Connecticut 

Radio Service Station

A Departure Which Means Progress for the Trade

One of the first Radio "Service Stations," as they might be called, has been established by the General Apparatus Company in New York City. It is situated in a section of the city that is largely residential, so that home radio enthusiasts find it convenient.

The company, whose service station is near the Broadway subway at 181st Street, advertises in the radio sections of the newspapers that it is always ready to solve the problems of the radio "fan." No matter how much or how little the "fan" knows, the company takes it upon itself to solve the perplexing problems. The service station is under the direction of Fred Klingenschmitt, who invites everybody with a snag, or a non-functioning set, or a statistical complex, to bring it to him.

This new service shows how quick radio business men are to get into the swing of their trade, recognizing that if it is to be a constantly growing industry, it must be ever-ready to serve the people. Radio is taking a leaf out of the automobile industry's notebook in the organization of its affairs. This is a wise step, for the automobile industry is one of the soundest in the country at present, being one of the first to recover from the business slump of 1920-1.

PATENTED TUBE SET

The audion tuning set produced by the Rosemark Radio Corporation of New York City is claimed by the manufacturers to be one of the best of the non-infringing tube sets.

An application for patents on the hook-up is on file in Washington. The new tuner is said to be very sensitive and simple for the non-expert to operate. All types of receivers manufactured by the company are designed uniformly to give a neat, compact appearance with a maximum of efficiency and durability. The instruments are mounted on polished bakelite with hard rubber switch levers and knobs, and a hand-rubbed mahogany cabinet. The feature of the article this corporation is manufacturing is the unreserved guarantee with which they stand behind every article which leaves their hands.

The Rosemark company also announce the distribution of tuning coils, mounted and unmounted, which are used in their set. A big summer sale campaign is being conducted by the company through their dealers.

Trade-Marks Secure Trade Registrations Secure Trade-Marks

I Secure Registrations

CHAUNCEY P. CARTER

Radio Trade-Mark Specialist

4907 Potomac Avenue, N. W. Washington, D. C.

Correspondents in all countries

"Distinctive Radio Apparatus"

THE NEW ROBBINS CONDENSER

Robbins
23 Plate
Variable
Condenser
\$3.25

Robbins
43 Plate
Variable
Condenser
\$4.00

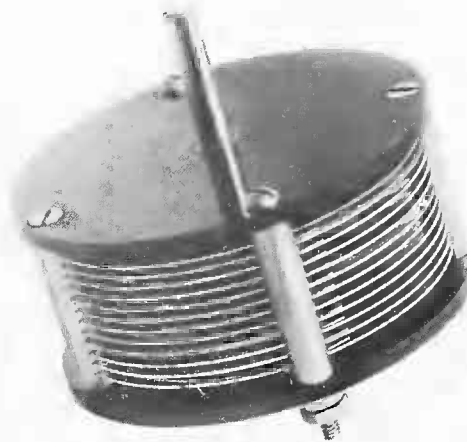

Robbins 3 Plate Vernier Condenser, \$1.50

Mounted on bronze bearings and die cast (not moulded or built up with washers), the Robbins Condensers never lose their alignment.

Distributors for All Standard Manufacturers

Send for Price List

Robbins

Electric Company

Established 1890

PITTSBURGH, PA.

What the Manufacturers Are Doing

Combined Receiver Hook and Switch

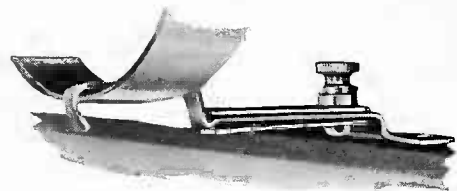

The Universal Radio & Manufacturing Company, 1809 Carter Avenue, New York City, has a new safety device for vacuum tubes which deserves special merit for its simplicity and adaptability in operation.

It is a receiver hook and vacuum tube switch combined. When the

phones are lifted from the hook (same as ordinary telephone) the tubes automatically light, and are extinguished when the phones are replaced on the hook. The "Hookswitch" is screwed under the edge of the radio table in an inconspicuous place where meddling hands will not touch the phones and both are invisible to the eye but within instant reach.

According to the recent announcement made by Chas. Skliar, general manager of the company, the "Universal" Variable Condenser both 43 and 23-plate has "passed the test" and is now ready for distribution throughout the country.

Radio's Geniuses

Busy Manufacturer, Earl C. Hanson, Always Inventing

The radio business is rich in talent. Take Earl C. Hanson, technical expert of the Globe Phone Manufacturing Company of Reading, Mass. He is the inventor of the only instrument for deaf mutes embodying the vacuum tube amplifier; he has invented a method of locating faults in street lighting, power mains, submarine cables and the like, and now he has demonstrated in New York harbor the practicability of guiding steamships through the densest fog by electricity. After the demonstration the United States Government installed the device under contract with Mr. Hanson's backers.

Mr. Hanson, who is only twenty-nine, is the technical expert of the Globe Phone Mfg. Co. He constructed for the town of Reading an apparatus for locating trouble in their street lighting system. It was only an experiment, but it was a success.

The equipment consisted of a water-proof coil, mounted on an automobile and connected to a vacuum tube amplifier. The feeble magnetic energy received from the electric circuit along the highway was amplified sufficiently to permit the "trouble man" to detect accurately the leaks, grounds or breaks in the circuit.

The coil on the machine was rotated to more accurately explore the faults, and in the case where trees were grounded to overhead wires, a small hand exploring coil was used.

The equipment can be used more specifically, for in case there are several trees in the vicinity of the suspected ground, the tree that is actually in contact with the overhead wire can very easily be picked out of the group by means of the hum heard in the telephone receivers when the coil is near the grounded tree.

In order that the "trouble man" can be in a position at all times to detect the hum from the wires, and distinguish it from other possible noises, a small instrument placed in the power house is used to produce an absolutely distinct musical tone in the telephone receiver.

Mr. Hanson's greatest is the Audio

Grebe RORD Two Stage Unit

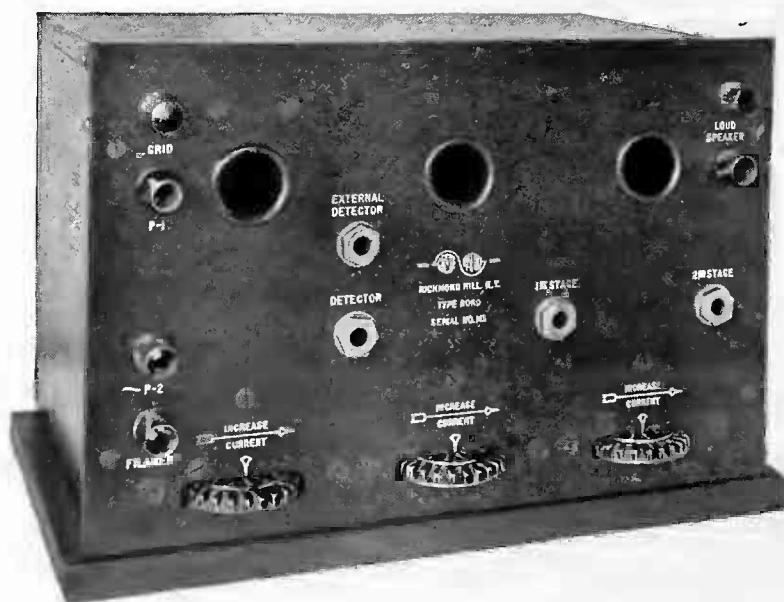

The Grebe Unit RORD, depicted here, is a combination of a detector and a two-stage amplifier unit. It is provided with an external detector jack by means of which the two stages of amplification may be used with an external detector circuit. This type may be used successfully with any type of receiver and is especially adapted for use with the Grebe Type CR-3. The RORD unit, with two special telephone plugs, retails for \$75.

Manufactured and distributed by the Grebe Radio Corporation, Richmond Hill, Long Island, N. Y.

Piloting Cable. Describing the test of this method of steering a ship through a fog, *Motor Boating* said in a recent issue: "One of Uncle Sam's big new destroyers was piloted from Ambrose Channel Lightship to the Narrows without the use of vision on the part of the pilot and helmsman. A canvas screen had been stretched completely across the pilot-house windows and the pilot stood facing aft. As far as visibility was concerned the conditions were equal to what would be encountered in the thickest fog in the middle of the very blackest night. The simple little apparatus that made this marvelous feat possible consisted of a pair of coils, one on either bow of the vessel and connected with a vacuum-tube amplifier which picked up the magnetic field created around a submarine cable energized by a low-frequency alternating current."

The United States Navy used the device during the war, and recently signed a contract for its use during the stirring times of peace, when the thrills of inventive genius supplant the excitement of slaughter.

NEW STYLOLECTRIC PEN

The Post Stylolectric Pen is an electrically operated writing stylus of good design and construction. It can be used on the ordinary D. C. or A. C. lighting circuits, and a lamp attachment permits the regulation of current flow, and controls the heating of the element.

It can be used to mark wood, leather, paper, fiber or any kind of material by means of colored sheets of transfer paper.

The holder is made of an insulating composition, which precludes the possibility of the current coming in contact with the body. A heating element provides the heat for the penpoint. Good ventilation is provided for at the base of the holder, so that the heating unit will not get over-heated, and burn out.

This pen will work on about a quarter of an ampere according to an expert who recently tested it. This current can be varied, for various purposes, such as for cauterizing, soldering, etc., up to one-half an ampere. An extra attachment, in the shape of soldering copper makes this pen very convenient for delicate soldering jobs in the laboratory.

It is furnished with instructions, transfer paper, six feet of cord and several attachments. The device is guaranteed for one year by the manufacturers.

It is made by the Post Electric Co., 30 East Forty-second street, N. Y.



Parts —

THE uniform quality and attractive prices of ABC Radio products bring profitable business to dealers who want advertised lines of quick turnover.

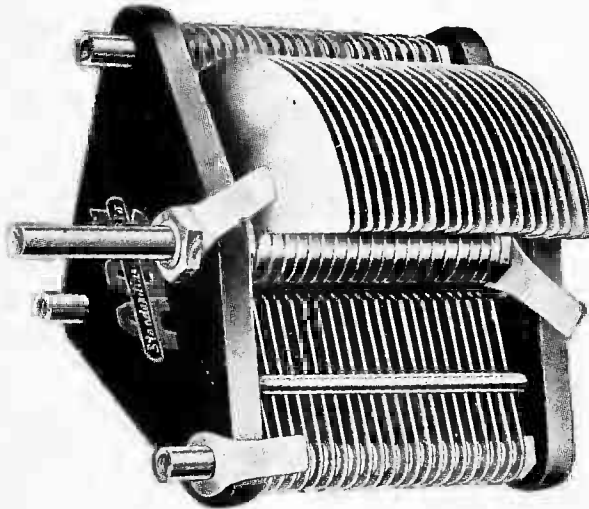

ABC Variable Condensers

MANUFACTURED in our own factory and containing many special features.

No.	Plates	Price
650-43	43	\$5.00
650-21	21	3.75
650-11	11	3.00
650-3	3	2.25

Send us your stock order on this big seller today.



ABC

Transformer

EVERY part securely fitted under pressure and the whole held together in one solid unit. Magnetic leakage is impossible in the A B C.

Price\$7.00



ABC

Headsets

TWO standard Murdock head phones with improved Signal Corps type headband.

No. 770—L2 — 2000 ohms \$8.50

No. 770—L3 — 3000 ohms 10.50

No. 770—ABC head-band alone. 1.50

Send today for full information about ABC Parts and how we help you sell them.

JEWETT MANUFACTURING CORPORATION
 342 Madison Ave. Dept. F7 NEW YORK

SCREW MACHINES IDLE

Battery of Seven Automatic Screw Machines for Making Parts for Radio Equipment.

SEND BLUE PRINTS AND SPECIFY QUANTITY

The Carlyle Johnson Machine Co.
MANCHESTER, CONN.

DEALERS!

We manufacture
Vario-condensors and Plates

10,000 in stock.

**Vario-couplers and condensors
Sliders Detectors**

IMMEDIATE DELIVERIES

Wireless Service

D. S. ROSEN

147 Fourth Avenue
Corner 16th Street

New York City

Stuyvesant 6582

Immediate Shipment
on

IRVINGTON

Flexible Varnished Tubing
"Spaghetti"

5000 Volts—Puncture Test

also on

**AERWIN
PRODUCTS**

Variocouplers
Variometers
Special Detector Crystal
Model A Receiving Unit
Collapsible Loop Antenna

"Kentone" Radio Amplifying Horn

WRITE

The Mills Radio & Electric Co.
Incorporated

1010 Springfield Avenue
Irvington, N. J.

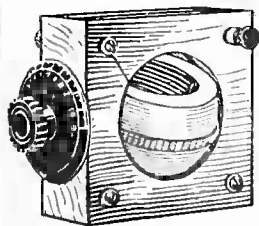
**FRANKLIN
VARIOMETER**

Made of select-
ed hardwood.
Permanent con-
tacts assure
smoothness of
operation, un-
surpassed by
any other make.

Price \$4.50

Sample sent prepaid \$3.50

Dealers Write for Discounts

FRANKLIN RADIO MFG. CO.
711 Penn Ave. Wilksburg, Pa.

TO INTEREST AMATEUR

What should be a strong pull for the radio enthusiast trade is manufactured by the Magnus Electric Company, Inc., of New York, in the shape of a code practicer and tester.

This is a new device made with a high frequency buzzer, complete with standard battery, enclosed in a box beneath a panel so that no other connections are needed. One feature of the tester is that it is of the size of the ordinary safety razor box, and may be conveniently carried in the pocket. All metal parts are nickel plated. The binding post is provided to test sensitivity of crystals. The international code with directions is placed on the inside cover of the box of the outfit, which is of neat leather-covered material. The list price is \$3.50.

Another item in the Magnus Electric Company's catalogue is the Magnus Loud Speaker. The horn of this is bell-shaped, designed to give the maximum of acoustic expansion, and the entire speaker is mounted on a solid slate base to exclude all external vibrations. The base also makes the loud speaker stable, so that no clamps or screws are needed. The outfit is heavily nickeled.

Other radio parts manufactured by the company are grid condensers, variometers and variocouplers, crystal detectors, free and enclosed, tuning coils, sliders, dials, knobs and binding posts.

FINE TUNING CONDENSER

With the view to giving the heart of the radio set, the condenser, wider range, greater selectivity and permanent adjustment, the Radio Shop, of Detroit, Mich., has designed a new Vernier type, which is called the Microdenser.

The manufacturer claims for this instrument a peculiar adaptability for the experimenter, because of its original shape. The accuracy, it is said, with which the microdenser can be adjusted enables the operator to tune out undesirable noises and signals heretofore impossible to eliminate. Due to a great range and fine adjustment, the maker says that it is possible to use this instrument for various circuits and purposes. The rated capacity of the microdenser is .001 mfd. When used in a vertical position the base may be filled with oil, thus increasing its capacity several times.

The microdenser is suitable for either table or panel mounting. Its convenient size, only two and one-half inches in diameter, lends itself to either mounting. The list price is \$7.50.

IMMEDIATE DELIVERY**DIALS**

**NEW YORK RADIO
DIAL CO.**

80 Beaver St. New York City

Dealers Attention

We are distributors for Grebe, Murdock, Federal, Fada and others.

We have a large stock of the above jobbers' products for immediate delivery. Send for proposition and discount sheet No. D.

**THE RADIO SHOP
OF NEWARK**

41 S. Orange Avenue
NEWARK, N. J.

**Jobbers and Dealers
ATTENTION**

ALL HARD RUBBER

**VARIOMETERS and
VARIOCOUPERS**

WILL NOT SHRINK

List \$7.00

Best Crystal Set on Market

List \$8.00

WRITE FOR DISCOUNT SHEET

PILOT RADIO MFG. CO.

63 RICHMOND ST.
NEWARK, N. J.

Farmers Will Buy

Bettered Conditions Permit Them to Purchase Desired Sets

By HERBERT METZ

Sales Manager Western Elec. Co.

Farmers, especially those in the Western states, are looking to the future with renewed optimism. I find after having just completed a tour of investigation through the agricultural districts of the country.

The Farm Bloc and the recent legislation put into effect for the farmer's benefit together, with the money the government has been lending him, have reawakened his confidence in the country, in farming as a profession, and in himself. Bankers seen report the constant liquidation of farmers' loans. Where before the rural financial institutions were overburdened with notes of the soil, they now hold a considerable portion of the coin of the realm. Currency is circulating more freely and the implements and merchandise that agriculturists generally buy in good times and which have been disregarded for the past year are beginning to move out to the farms where they belong.

Business is best I find in those communities where diversified farming is practiced—and the diversified farming idea is spreading. Farmers are awakening to the realization that the man whose eggs are scattered in many well guarded baskets may lose some of them without incurring complete failure.

Dealers and storekeepers across the continent consider the increase in farmers' purchases a reflection of the high spirits aroused among their customers by the belief that the prices of grain and other farm products are up with every indication of staying up. Where last year, sheep ranchers and cattlemen in the area I visited were selling at a loss, they are now making money on current sales. These profits will be augmented by the recent reduction in freight rates.

On the other hand, the prices the farmer pays for what he buys today are lower than in 1921. Consequently, he now can swap labor for considerably more of everything he wants. As an example, it took 570 bushels of grain to buy an electric power and light plant of the so-called "farm type," today the same apparatus can be acquired for 390 bushels. Radio business among rural farming districts will increase, because now the farmers have the money to buy the instrument that will bring the life of civilization around their very ears.

BAKELITE-MICARTA RADIO PANELS

USED ON BEST WESTINGHOUSE SETS

PROMPT DELIVERY

ANY SHAPE, THICKNESS OR QUANTITY
STANDARD SIZE PANELS IN STOCK

Write for Jobber and Dealer Proposition

BRAUN GEAR CORPORATION

1321-25 GATES AVENUE

BROOKLYN, N. Y.

Ask Our Service Bureau

THE STORM-LEE MULTIPLEX ROTARY SWITCH

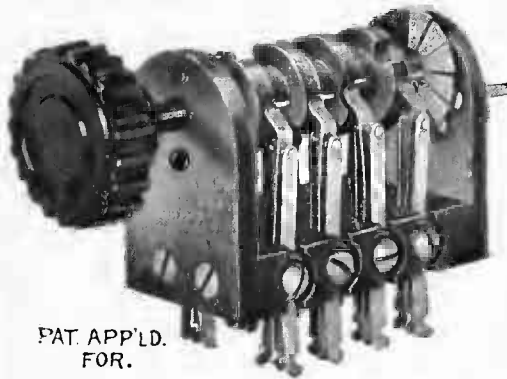

PAT. APP'LD.
FOR.

JOBBERS—DEALERS

This switch is revolutionizing amplifier construction, owing to convenience of operation. It will be to your advantage to write for our attractive proposition.

MANUFACTURERS

Why not use this switch in your sets? Write for details.

The Perfect Amplifier Switch Gives Complete Control of Detector and 1, 2 or 3 Stage Amplifier, Including Automatic Filament Control.

The MULTIPLEX ROTARY SWITCH takes the place of filament control jacks in the vacuum tube control panel, giving much greater convenience at lower cost. With this switch you may change from detector to any desired stage of amplification by merely turning one knob. Filaments of unused stages being automatically extinguished.

UNIVERSAL IN USE

This switch is adjustable, by loosening one nut the cams may be adjusted to meet practically any switching requirements.

SPECIFICATIONS

INSULATION—BAKELITE

SPRINGS —NICKEL SILVER

CONTACTS —STERLING SILVER

LIST PRICE - - - - \$5.00

Write for Discounts

STORM-LEE RADIO APPARATUS CO., 742 Highland Avenue, Newark, N. J.

ANNOUNCING KLEIN'S CONDECTOR

(REG. U. S. PATENT OFFICE)

LIST PRICE \$2.00

No. 5050

Other
"KLEIN"
Super Products

Tuning Coils
with Roller
Bearing
Sliders

Amplisite
Tested
Crystals

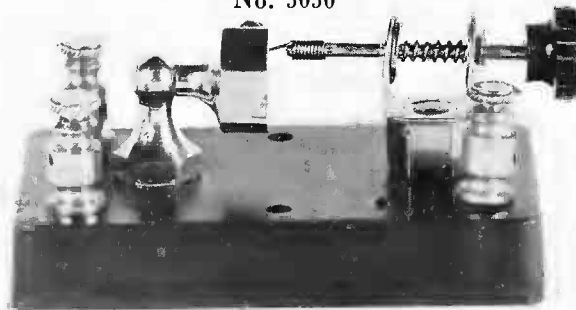

Other
"KLEIN"
Super Products

Bakelite and
Brass Binding
Posts

Detectors

Condensers

A sturdy crystal detector, mounted on a high grade moulded hard rubber base, parts of solid brass highly nickle plated and with CONDENSITE handle knob. It has a fixed condenser of .002 Micro Farad capacity incorporated in the base and is furnished complete with a famous AMPLISITE crystal. Internally wired and arranged with binding posts for receivers and ground.

FURNISHED COMPLETE IN A NEAT LITHOGRAPHED BOX TOGETHER WITH WIRING INSTRUCTIONS.

WITHOUT A DOUBT THE MOST PRACTICAL AND COMPLETE INSTRUMENT YET SHOWN FOR RECTIFYING MINERAL SETS

To Be Had at the Country's Leading Jobbers or Direct from the Manufacturers

THE KLEIN ELECTRIC MFG. CO., 67 Spring St., New York City

"THE BEST  IN RADIO"

See Page 9

Motors For Winding



Variometers,
Couplers, etc.

Powerful and
Durable.
Guaranteed.
Occupies a very
small space.

VARIABLE SPEED
Foot Rheostat
Control.
Leaves both hands
free.

Aluminum
Casing.

RUNS FORWARD
AND BACKWARD.
INSTANTLY RE-
VERSED on any
current.
Specify.

Sells at \$28.50

Write for quantity prices

HENRY PAULSON & CO.

DISTRIBUTORS

37 So. Wabash Ave. CHICAGO

THE KENTONE RADIO AMPLIFYING HORN



Made of brass, highly polished and nickel plated. Fifteen inches high, six inch bell

RETAILS FOR \$6.00

Write for particulars

F. C. KENT CO.

IRVINGTON NEW JERSEY

HIGH STANDARD UNITS

With the idea of having radio enthusiasts add steadily to their equipment in proportion as their knowledge and buying power increases, the Essex Radio Service, Newark, N. J., has developed a series of quality units.

The first is their "Type R" Tuner, with a range of from one hundred and fifty to twenty-five hundred meters. No variable condenser is necessary with this tuner, but there is a secondary variable condenser, in conjunction with a secondary load, which together give sharp tuning in the secondary circuit.

Another instrument manufactured by the Essex Radio Service is a combination of the Type R Tuner with an audion detector, making a complete receiving set, for use with ear phones. For those already possessing a tuner, the company has designed an audion bulb detector and a two-stage amplifier, which can be used with a loud speaker. The two-stage amplifier is also made separate. The fifth instrument which the Essex Radio Service makes is a combined tuner, detector, and two-stage amplifier.

All the instruments are made of quartered oak in dark mission finish, with condensite panels, nicked binding posts and standard easily adjustable dials.

LARGER PRODUCTION FOR BALDWIN'S

The Baldwin Telephone Company of Salt Lake City has incorporated for \$1,000,000, and will construct a factory capable of turning out from 1,000 to 3,000 head sets per day in the very near future.

It is said that the present production of the Baldwin phone is not over 150 sets per day, due to the desire of Nathaniel Baldwin to produce a carefully-made, personally inspected head set.

Those who know will agree that the Baldwin phone is really one of the best for radio purposes.

EVOLVE TRANSFORMER

The result of six months of steady experimentation, the Acme Apparatus Company announce their new Radio Frequency Transformer. It is workman-like in appearance, and the manufacturers feel that they have produced the best transformer for wave lengths of 150 to 500 meters. This transformer, they declare, is worthy of its predecessor, the Acme Audio Frequency Transformer A-Z. The Acme Apparatus Co. have been making Radio apparatus since April, 1919.



Echophone Loud Speaker Sets

IMMEDIATE DELIVERY

Discounts to jobbers and dealers
AERIAL WIRE.

19 strand tinned silicon bronze
VARIABLE CONDENSERS

11-21-23-43 Plate

EISEMANN HEAD PHONES

Super-sensitive

Variometers

Variocouplers

Binding Posts

Contact Points

General Auto Electric Co.

231 Halsey St.

Newark

New Jersey

FOR IMMEDIATE DELIVERY

Paragon 3A10

DeForest MR6

DeForest Honeycomb Coils
and Mountings

also

Complete Paragon and De
Forest Line and other stand-
ard parts.

Tubes and Homchargers

Ask about the Famous
"FERA"

Variometers

Variocouplers

Variable Condensers

Everything for the

Jobber and Retailer

**Federal Radio &
Electric Company**

41 PARK AVENUE

Paterson, N. J.

M-R FLEXIBLE VARNISHED TUBING
THE GENUINE
"SPAGHETTI"
TWO STYLES—BEST GRADES MADE—ALL
SIZES—ALL COLORS
Varnishes, Waxes, Compounds, Papers, etc.
MITCHELL-RAND MFG. CO.
14 VESEY STREET NEW YORK, N. Y.

States Radio Corporation



501 So. Jefferson St.
Chicago
Manufacturers of
High Grade Equipment
Jobbers and Retailers

A Quick-Money Proposition for You
2 Stage Radio Frequency Detector.
2 Stage Amplifier.
Each in a handsome mahogany case.
No wiring to do.
Tunes to all wave lengths, local and long-range.
Very clear.
Just what the Public is hungry for.
Immediate Delivery
Send for List and Discounts

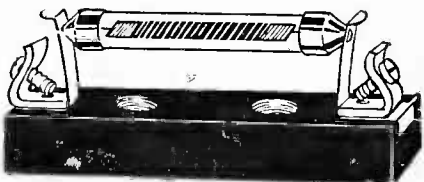

PRECISION

GRID LEAKS AND MOUNTINGS
Resistance ranges from .05 megohms
to 5. megohms. Accuracy guaranteed.
Grid Leaks75c
Mountings35c

Radiophone Equipment Co.
47 New Street Newark, N. J.

RADIO'S Most Valuable ASSET

is perfect attunement. Perfect attunement is impossible without perfectly soldered connections. With this simple invention any one can make permanent soldered connections on all parts, no matter how delicate. For professionals and amateurs. Used and recommended by hundreds. Works on any circuit, A. C. or D. C. Also battery.

\$7.50

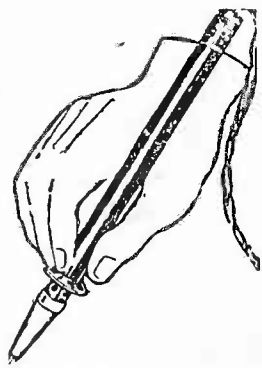

Fully
guaranteed

Small Soldering Easy

A FEW OF ITS OTHER USES

Writing or Designing in Gold, Silver and Colors on

Bakelite Products	Leather Articles
Baggage	Wooden Novelties
Sporting Goods	French Ivory
Fiber Products	Glass and China
Redmanol Products	Formica

DEALERS AND JOBBERS WRITE FOR DISCOUNTS

THE POST ELECTRIC CO.
30 East 42nd Street
NEW YORK CITY

Fall Prospects

What the Business Barometer Predicts Should Come

By K. M. JONES

Mercury Radio Products Co.

Foremost in the mind of every dealer and jobber is the question of fall business. Previous to May 1, 1922 licenses for broadcasting were issued, and this number will be greatly augmented by September. These figures make plausible the estimate that one-half of our entire population will soon be within close range of a broadcasting station.

With these facts in mind, coupled with the knowledge that the public interest has not lagged, it does not require a great deal of foresight to predict that the close of warm weather will bring Radio interest up to fever pitch throughout the country.

The nature of this larger demand will differ, however, in that the phenomenal growth of the Radio business has arrived at a point where it is ready to be placed on a sound commercial basis. Therefore, the stability of wireless broadcasting will be in great part due to the manner in which the dealer satisfies his customers now. Much has been said from a technical standpoint, but let us leave out the phrases that the average radio fan pretends to understand, but doesn't, and consider the situation from a commercial angle.

The controlling factors, roughly are, first, the quality and type of broadcasting. Second, the quality and cost of reception. Considering the first, it is not an exaggeration to say that each month produces tremendous strides towards perfection in transmitting and it is also becoming apparent to many that broadcasting will be an essential in the business world as well as an after-dinner aid to digestion. The time is not far off when the farmer, particularly, will not afford to be without a receiving outfit.

The second factor presents the problems with which the dealer is more closely concerned. Regardless of the individual's desires in the matter of Radio sets, there comes a point when the buying limit is reached. The dealer who can approximate that limit and concentrate on articles in the same price class will naturally receive the greatest volume of business.

As in most other fields, is it not reasonable to assume that the bulk of business in wireless sets and instruments will be done in medium price articles rather than the very cheap or overpriced goods?

In the first place, more crystal sets of the better grades should be sold in

The Little Wonder MAGAFONE Loud Speaker. The only cabinet Loud Speaker sold—Better than any horn. From your Dealer or Direct.

\$6.50 PREPAID.

HERMAN H. SOHN CO.

65 Douglas Ave. Providence, R. I.
Dealers Write for Proposition

CODE CHARTS

CONTAINING

International Morse Code, Numbers, Punctuation and "Q" Abbreviations. Two sizes, 12 x 16 and 24 x 30.

Dealers, Send for Samples and Prices

H. C. WILEY

48 Monroe Street Hartford, Conn.

Ask Our Service Bureau

Stanton's WIRELESS Bulletin



The Authority on Wireless Stocks

Reynolds Spring Co.

Radio Corp. of America Spanish Marconi
American Marconi Canadian Marconi
English Marconi Federal Tel. & Tel.
De Forest Radio Tel. & Tel.

FRANK T. STANTON & CO.
Broad 5819 35 Broad St., N. Y. C.

Manufacturing Possibilities

Screw Machines—Lathes—Punch Presses — Winding Equipment, Etc. — All Available for the Manufacture of

RADIO APPARATUS

and

RADIO ACCESSORIES

Submit Blue Prints or Specifications for Estimates

We Can Manufacture It for You

STEEL PRODUCTS MFG. CO.

4613 Roosevelt Road
Chicago, Ill.

localities adjacent to broadcasting stations as such sets are inexpensive, self-contained, and with proper care should last indefinitely. In most cases the reception is equal in quality to that of sets costing much more.

There will, undoubtedly, be a large increase in the demand for the less expensive vacuum tube sets, non-regenerative as well as regenerative circuit. These outfits are becoming more popular as they are within the reach of the average citizen's pocketbook and are easily added to later when the owner feels better able to afford it.

Dealers in various localities are already beginning to place orders for tested instruments of medium price in anticipation of the fall business. This appears to be a wise policy as the demand will unquestionably outgrow the supply, particularly around the latter part of the year when it is estimated that three months production will be necessary to satisfy the demands of Christmas shoppers.

ACE BINDING POST

The H. H. Eby Manufacturing Co., 605 Arch street, Philadelphia, have designed a new binding post similar to their ensign and junior posts, which are already familiar to the trade, and embodying many of the novel features which have made their line so popular for use on radio apparatus.

This post, which they have named "Ace," has a nickel-plated brass base with solid 8-32 threaded stem extending approximately one-half inch below the base. The base of the post is heavily knurled to prevent turning when mounted, and a hole is drilled through the neck sufficiently large to take a No. 15 bare wire.

The post is supplied with a black insulated knob one-half inch in diameter by approximately seven-sixteenths of an inch high, and makes a very attractive post for use on certain apparatus.

A RELIABLE HOUSE

The H. C. Roberts Electrical Supply Co., with headquarters in Philadelphia, are doing extensive wholesaling of radio lines throughout the east, under the supervision of Mr. Fisher, an experienced radio man. The House of Roberts has been well known for years as a reliably electrical jobbing house, with branch offices in Syracuse and Washington, D. C. The firm makes it a point to handle nothing but the most dependable lines in radio, and is doing a business that at present is only limited by the supply.

ATWATER KENT

RADIO APPARATUS

VARIOMETERS
TRANSFORMERS

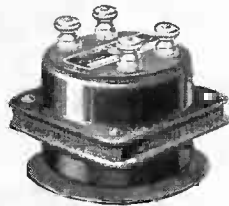

TRANSFORMER

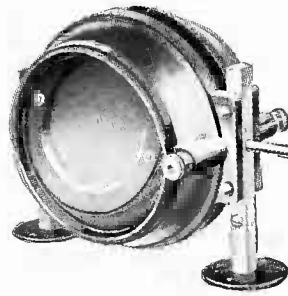

VARIOMETER

VARIOCOUPPLERS
RHEOSTATS



RHEOSTAT

Designed in the Atwater Kent Research Laboratories and manufactured complete in this plant from moulding of the condensite forms to winding of the fine wire coils—an assurance of quality.

Highest grade materials are used in construction thruout each unit and a very complete final test is a guarantee of 100% performance.

Correspondence solicited

ATWATER KENT MFG. COMPANY

4941 Stenton Ave.

Radio Dept.

Philadelphia, Pa.

ASK OUR SERVICE BUREAU



\$3.75

MADE
IN
NEWARK
N.J.

Rad'O Crystal Attachment

For Your Crystal Set Use One Ear Phone, a RAD'O and the Whole Family Can Listen In

Made of Aluminum—and designed according to the laws of acoustics, and guaranteed to give satisfaction. Tubes of best quality rubber, with heavy walls; the ear tubes made of hard rubber and easily kept in sanitary condition. By the use of the Rad'O all distortion is eliminated.

Jobbers
Communicate

RAD'O, P. O. BOX 418, NEWARK, N. J.

Dealers Ask
Your Jobber

Solder Your Connections

for best results. Get the "Wonder" a Self Heating Iron. Use it anywhere without stove. No workshop complete without it. Cheap to operate. Generates own vapor in two minutes. Absolutely safe—a child can operate. Nothing to get out of order. Use it as a blow torch also. Boxed complete with solder, salamoniac and full soldering directions. **Send No Money**—just your name and address on a post card. When the postman delivers, pay him \$2.50.

Dealers—a big seller, write for proposition.

North Shore Radio Works, Dept. B-601
810 Davis Street, Evanston, Ill.

ATTENTION!

Manufacturers of high class guaranteed Radio Sets and equipment. An efficient selling organization is open for connections as Factory Representatives.

Radio Sets must be high class, yet moderately priced, and able to receive concerts and other news a distance of at least one hundred and seventy-five miles.

James R. Sheedy

Executive Office

Press Bldg., Binghamton, N. Y.

The Comet Battery Co.

Manufacturers

Radio "B" Batteries

Cleveland, Ohio

JOBBER—DEALERS

ATTENTION

Radiophona No. 2

CHEAPEST AND BEST **VACUUM**

\$20.00 TUBE SET

IN MARKET

Cabinet, Mahogany. Size, 7½ x 7½ x 6 inches. Panel, Bakelite, Nickel Trimmings. Equipped with Famous FADA Rheostat, Socket and Switch.

SHARP TUNING QUALITIES and Range are features of Radiophona No. 2.

DELIVERIES IMMEDIATE

LIBERAL DISCOUNTS

to Jobbers and Dealers

We can make immediate deliveries on our famous Radiophona No. 1. Most efficient and complete crystal set on market. \$32.50 includes Aerial Equipment and Mesco Double Head Sets.

MADE BY

M. P. RADIO CO.

453 W. 53rd St. New York City

SUPERIOR'S NEW STAND

The Superior Engineering Company have opened up a Philadelphia Branch office. The company is manufacturers' representative for radio and electrical apparatus. They are the exclusive sales representatives of the Clapp-Eastham Company, manufacturers of a line of regenerative sets, licensed under the Armstrong patents; the WorkRite Manufacturing Company, with a line of variometers, switches, rheostats, dials, etc.; the Premier Radio Corporation, of Detroit, Mich., makers of radio parts; the Apex Electrical Specialty Company, Newark, New Jersey, maker of the Jacobus Lightning Protector, used for protecting aerials; and the Signal Electric Company, of Menominee, Michigan, throughout Pennsylvania except Philadelphia. The last-mentioned firm makes tuning coils, loose couplers, and various parts for sending and receiving sets.

The Superior Engineering Company declares that it does not carry any stock nor invoice any orders from its office, as all this work is done in the office of the individual factory. Dealing with the company is equivalent to dealing with the factory, and the discount schedule which the factory uses is used exclusively in its sales work.

A PERSONAL ITEM

Jack Goldman and Sam Friedman, composing the well-known Friedgold Company, "the boys that sell anything from Eskimo Pie to the Esquimos, to hot lemonade to the residents of the Equator," are now the New England distributors of the Radio Company of New York, handling the Racony Plug. These two boys have more than made good and are a very valuable asset to the radio business.

Very shortly the New England Roads will be seen crowded by Mr. Friedman's brand-new Norma car. For the information of the uninitiated the Norma car is a mile long, and has a pure aluminum body. It can't be missed. If Sam makes a bad turn getting into Boston, he must back up all the way to Washington, D. C., to turn around.

NEWARK RADIO SHOW

A radio exposition will be held at the Robert Treat Hotel, Newark, late this year, and will be managed by the Merchants' Co-operative Advertising Agency, who conducted the last Newark show at the same hotel. Space is limited to one hundred exhibitors.

IMMEDIATE DELIVERY

ALUMINUM

SUITABLE FOR RADIO PARTS
Moulding, Bar, Rivets, Tubing, Ingot
STRAHS ALUMINUM CO.
53 Grand Street, N. Y.

JOY-KELSEY CORPORATION

Manufacturers
RADIO EQUIPMENT

4021 West Kinzie St. Chicago Ill.

**Ask Our
Service Bureau****E. P. RADIO CO.**

We design and manufacture all sorts of Radio Parts, Condensers, Variocouplers, Crystal Detectors. We also conduct various experiments and research for firms desiring this service.

Write, phone or call

E. P. RADIO CO.

134 Joralemon St.

Main 1285

Brooklyn, N. Y.

EVEREADY**RADIO "A" BATTERY**

Immediate Delivery from Stock

Manhattan

Storage Battery Co., Inc.

204 West 76th Street

New York City

**R-O-V-A
RADIO PRODUCTS**

Lowest List

Highest Discounts

*Everything for the
Radio Dealer*

R-O-V-A

Detector-Tuner—Two Stage

\$45.00 Net

Jobbers Wanted

Self-Service Phonograph Co.

Incorporated

167 West 18th St.

New York City

Ship Display

**Pittsburgh Firm Send Radio Sets
3,500 Miles**

The Radio Electric Company of Pittsburgh, pioneers in the manufacture and distribution of radio apparatus, shipped a radio display to The Emporium, San Francisco's largest department store, for exhibition in The Shriner's Radio Show last week. Although the distance was 3,500 miles, this enterprising concern sent enough apparatus for display to start a small store, in addition to distributing thousands of pamphlets and circulars of different representative lines of radio equipment. The company was represented by Mr. Higby, purchasing agent and credit manager, and Mr. Curley, assistant sales manager, who were in charge of the company's booth at the show.

The general direction of this show, held in honor of the Shriner's convention, was in the hands of Mr. Charles S. Mauzy, of The Emporium. A very entertaining program was given daily, which consisted of motion pictures on the action of various radio phenomena, radiophone concerts, orchestra music, aesthetic and fancy dancing.

AMERICAN TELEPHONE CO.

The American Telephone and Telegraph Company has more stockholders than any other corporation in the country, the number recorded in April, 1922, being 201,000. The book value of the plant and equipment of subsidiary companies is \$1,569,000,000, on which 5.2 per cent was earned in 1921. The divided profits of these companies, paid into the American Telephone treasury, was equivalent to 11.1 per cent on the parent company's stock in 1921. Earnings on the stock averaged 10.06 per cent in the twelve years ended 1921. The company holds \$840,208,000 stocks and bonds of associated companies and has a property account of its own valued at \$139,718,000. Net tangible assets applicable to the capital stock equaled \$119.81 a share on December 31, 1921. On that date current assets exceeded current liabilities by \$46,314,000. Capital stock of the American Telephone outstanding is \$548,185,300 and the funded debt \$300,699,900. There was a profit and loss surplus of \$108,604,000 at the end of 1921. Range of stock since 1901; High, 186 in 1902; low, 88 in 1907; low in the last five years, 90 $\frac{5}{8}$ in 1918.

HAVE YOU SEEN THESE LATEST EBY ADDITIONS?

They Sure Have Made a Hit

Write for Bulletin No. 10



Commander "H"



Ensign "H"



Ace



Sergeant "SS"



Buddy

We have a substitute for the post you are now using. Delivery from stock.

THE H. H. EBY MFG. CO., 605 Arch Street Philadelphia, Pa.

LIVE WIRE DISTRIBUTORS, WRITE FOR OUR INTERESTING PROPOSITION

"LISEN-IN" HEAD PHONES

The "LISEN-IN" Head Phone is the acme of perfection in a popular priced phone. It is of the two pole type, 3,000 ohm capacity, thus offering a very high degree of resistance. Built for hard usage, but extremely sensitive. Adjustable to any shape head. Compact, but feather weight. Sanitary head bands.

Our faith in LISEN-IN head phones is such that they are sold on a money back guarantee basis if they fail to give entire satisfaction.

THE PRICE IS \$7.50, including two head set receivers
sanitary head band and forked cord.

Manufactured by

NATIONAL RADIO COMPANY
50 Union Square, New York

We Also Manufacture DIALS, VARIABLE CONDENSERS, ROLLER BEARING SWITCHES and OTHER PARTS

Here At Last!

Here is the Radio Frequency Transformer for which radio amateurs and experts have long been looking. It embodies all of the desirable features and yet is moderately priced.

Dreyfuss Radio Frequency Transformer

The addition of this high class product to the Dreyfuss line is the result of months of experiment on the part of our engineers. Exhaustive tests having convinced that it is perfect we are now manufacturing it for the market.

This transformer is designed to cover the amateur wave length efficiently, giving the maximum amplification on each stage. The transformers are supplied separately at \$4.75 each, list. Furnished as radio frequency units complete with rheostat, socket, etc., for \$14.00 list.

P. M. DREYFUSS CO., Inc.

150-152 Chambers Street - - - New York City

We Specialize in

Brass Rod and Tubing
Sheet Copper, Aerial Wire
and Binding Posts

McKenna Brass and Mfg. Co.

First Ave. and Ross St., Pittsburgh, Pa.

Phone, Court 637

T-B-H Head Sets

List \$8.00

Sold on a Money Back Guarantee
8000 TURNS PER RECEIVER
(2000 Ohms Resistance)

Aluminum Backs
6 Ft. Moisture Proof Cord

Jobbers—Dealers
Write for Discounts

Telephone Book Holder Corp.
Dansville, New York

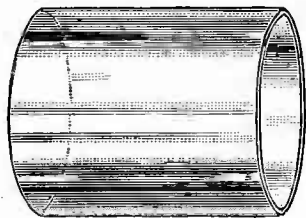

Glass
Tubes
for
Crystal
Detector
Sets

Special Prices in Quantity

Vineland Scientific Glass Co.
New York Office 1133 Broadway
Factory Vineland, N. J.

MANUFACTURERS JOBBER—DEALERS

"UNIVERSAL" VARIABLE
CONDENSERS—

43 Plate List.....\$4.00
with Dial 4.75
23 Plate List..... 3.25
with Dial 4.00

"UNIVERSAL" HOOK SWITCH
—List \$1.25

A vacuum tube, switch and receiver hook in one. A safety device serving a double purpose.

GERMAN SILVER DIALS—with special design taper knob. 3 1/8 inch diameter with quarter-inch hole. List 90 cents.

VACUUM TUBE SOCKETS —
Moulded base. List 90 cents.

SWITCH LEVERS—List 45 cents.

WRITE FOR ATTRACTIVE DISCOUNTS

**Universal Radio
and Mfg. Co.**

1809 Carter Ave., New York City

New Radio Bill

Broadcasting Rules Now Up to
Congress

Following the recent conference on radio, under the supervision of Secretary of Commerce Hoover, a bill has been introduced into Congress. A summary follows:

The bill presented is not a comprehensive radio law. It leaves the act to regulate radio communication, approved August 13, 1912, as the basic law upon this subject. The bill, in addition to granting enlarged powers of regulation, undertakes to clarify certain ambiguities in the present law and adds to existing law a number of sections of minor consequence.

Section 1-B is considered of vital importance for it will authorize the establishment of various broadcasting services which are of such great interest to the public and will permit all the other classes of service recommended by the conference to be established and safeguarded from improper interference. The twenty classes of stations recommended are not exclusive of others.

Paragraph D of Section 1 authorizes the President in time of war or of public peril or disaster to cause the closing of any radio station or to authorize the use and control of any such station by any department of the government. This provision is not new.

The concluding sub-paragraph of Paragraph C is of general interest. There has been a somewhat prevalent belief, and there was some evidence to justify the opinion offered to the conference, that certain large manufacturers of radio apparatus, through the ownership of essential patents and through contracts with selling agencies and by other means, were unduly restricting the manufacture and sale of desirable apparatus. In view of this situation the committee believed that it was proper and in harmony with the general theory of the bill with respect to the issuance of licenses to specifically authorize the secretary to refuse a license to any person or corporation which in his judgment was monopolizing or seeking to monopolize radio communication through the control of the manufacture or sale of radio apparatus. This sub-paragraph gives this power.

Section 6 is also a new provision. In the interests of safety at sea it requires that radio telephone stations the signals of which can interfere with ship communication shall keep a

Fine Cuts for Illustrating
**CENTRAL ELECTROTYPE
FOUNDRY COMPANY**

Electrotyping and Engravings

9 Campbell Street Newark, N. J.
Telephone: Mulberry 1698

Ask Our Service Bureau

ROTORS

Perfect automatically turned
BIRCH DRY KILNED, 3/4 diam., 2 1/4 high

LIST, 25 cents
Liberal Discounts

All sizes and all woods. Variometer and variocoupler parts supplied at prices far below all other makes.

COIL ENDS THE R. C. MILLS BASES, etc.
30 East 23d Street New York City

MANUFACTURERS

and

JOBBERS

LIVE WIRE SALESMAN

Thoroughly experienced in the sale of radio equipment and parts desires to represent a reputable concern in the field.

I am familiar with outlet for this equipment in Canada and Great Britain and can produce substantial returns in that territory, or any other.

For appointment write to Box T
RADIO DEALER

Jobbers and Dealers

Attention

STEEL—COPPER—BRASS

BRONZE—ALUMINUM

NICKEL SILVER

NICKEL—MONEL

DIAPHRAGM STEEL

MAGNETIC IRON

MAGNET STEEL

for

GUIDE RODS—SLIDES—TUBE

SOCKETS — CORES — METAL

PARTS — STAMPINGS, ETC.

used in the manufacture of
RADIO EQUIPMENT

"COPPERWELD"

ANTENNA WIRE

Immediate Shipment

Steel Sales Corporation

129 So. Jefferson St.
Chicago, Ill.

licensed operator listening in on the wave length designated for distress signals during the entire time the transmitter of such telephone station is in operation.

The President is authorized to allocate wave lengths to be used by government stations. The bill provides only for government control over transmitting stations. The issuance of licenses is made discretionary, not compulsory. The license runs ten years with a renewal option; it also provides for revocation upon cause.

RADIO BOOSTS SALES

The radio-set as a sales booster was emphasized at the sixteenth annual convention of the National Association of Talking Machine Jobbers held at Atlantic City.

It was the declaration of speakers that thousands of people who never before paid any attention to phonographs were attracted by the good music and marvels of the machines in the broadcasting that has become general with the wireless fever now epidemic.

According to reports submitted by Frank D. Waller, of New York, first vice president, there has been a tremendous boost in sales since wireless ascended to such big popularity.

MAKE QUALITY SETS

The Profco Manufacturing Company of New York may be said to have started in the radio business years before there was such a business. To be explicit, they were in on radio fifteen years ago.

This was the time when the members of the company served on the seas as wireless operators. Their names are W. J. Bear, E. E., President; H. Q. Horneij, Vice-President and Technical Engineer; and Samuel Schneider, Secretary. Backed by their long experience, they began the manufacture of commercial sets two years ago, so that even in this branch of radio they may be called pioneers.

The product of such men is, in the natural course of events, a quality product. Their experience has enabled them to add neatness in appearance, excellence in design and simplicity in operation as other qualities of their sets.

In order to broadcast a talk on the development of commercial aviation from the L. Bamberger & Company of Newark Broadcasting station, Henry A. Bruno, captain of the Aeromarine Airways Company of New York, made the trip by airplane.

**ROSEMARK
RADIO
RECEIVING SETS
THE SIMPLEST TUNER MADE**



Rosemark Two-Stage Unit
(Pat. Applied for)

Three Styles: Detector, One Stage, and Two Stage
Actual Size all Units, 16 x 6½ x 6

Every Instrument Tested and *Guaranteed* Against Electrical or Mechanical Defects

LIST PRICES

Detector Unit.....	\$28.00
One Stage Unit.....	\$40.00
Two Stage Unit.....	\$50.00

DEALERS Write for Discounts } and Proposition
JOBBERs Write for Territory }

**ROSEMARK
RADIO
CORPORATION**

Manufacturers of Radio Apparatus
29 Lexington Avenue
New York City

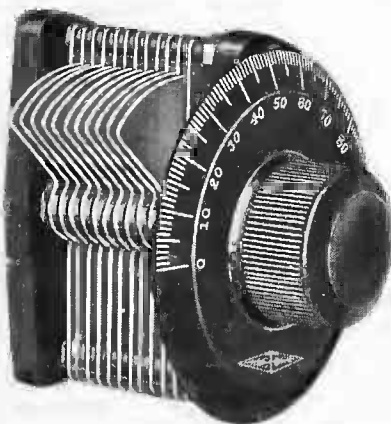

We KNOW how to manufacture Radio—having had an extensive previous experience in the design and production of numerous high-grade electrical specialties.

When radio came we did not have to start amateurishly. We had the organization and facilities to take the natural forward step.

THE "BESTONE" LINE INCLUDES

- | | |
|--|--------------------------------|
| Variometer | Telephone Plug |
| Vario-coupler—150 to 600 Meter | Closed Circuit Jack |
| Vario-coupler—150 to 580 Meter | Open Circuit Jack |
| Amplifying Transformer (Mounted) | Two Circuit Jack |
| Horizontal Crystal Detector (Glass enclosed) | Filament Rheostat |
| Vertical Crystal Detector (Glass enclosed) | Mounted Galena |
| 3" Dial | Crystal Cups |
| 2½" Dial | Midget Insulators |
| 3000 Ohm Headset (Navy Type) | Ball Insulators |
| 2200 Ohm Headset | Metal Binding Post |
| Inductance Switch | Composition Binding Post |
| 23 Plate Variable Condenser (.0005 MFD) | Large Metal Binding Post |
| 43 Plate Variable Condenser (.001 MFD) | Large Composition Binding Post |
| V. T. Socket | Switch Points |
| | Switch Stops |
| | Switch Levers |
| | Phone Condensers |
| | Grid Condensers |
| | Filament Rheostat with Dial |

Write for Sales Proposition

HENRY HYMAN & CO., Inc.

Manufacturers

NEW YORK
476 Broadway

SAN FRANCISCO
711 Mission St.

CHICAGO
212 W. Austin Ave.

CATERS TO AMATEURS

The Simplex Radio Company, of Philadelphia, has been doing an extensive business in panel units ever since the radio craze hit the country. It has been the idea of Mr. McGear of the Simplex company to cater to the amateur who wishes to experiment with his set, and have apparatus that will look neat and finished when unassembled for experimenting purposes. The neat appearance and scientific precision of all parts of the Simplex make have made the Simplex trade-mark a by-word among all who have used them.

Mr. McGear was one of the first Philadelphia manufacturers to step into the radio game, and his aim has always been to put quality before quantity. Due to immense increases in his producing capacity in the last few months, he is now ready to take orders of any size, and is also considering the production of a complete set to bear the Simplex trade-mark. It is Mr. McGear's pride that dealers of wisdom keep inferior parts in stock to show just how much better the Simplex parts are.

Distribution of Simplex products is being handled mainly by the Electric Service Supplies Company, manufacturers for the last thirty years of lightening arresters for radio and other purposes. The Simplex company, however, is distributing to its own trade. An interesting pamphlet for a dealer to read is the new Simplex catalogue, which describes completely, with the aid of cuts, the Simplex line.

FINE LINE FOR DEALERS

The General Radio Laboratories, Inc., with headquarters in the Tribune Building, Chicago, offer unusually attractive propositions to reliable dealers in the "General" line.

This line includes the Red Star telephone receivers; the Linga Variable Condenser, and the Non-Leak Variable Air Condenser, Vernier Type.

The Red Star is an extra power, super-sensitive, synchronized and radio-tuned 'phone. Made as the result of twenty-five years of telephone making they are highly efficient and mechanically perfect.

The Linga Variable Condenser with Vernier attachment, consists of one movable plate apart from the rotor of the condenser, enabling finer adjustment when tuning in, as but one plate is moved instead of all.

The Non-Leak Variable Air Condenser, Vernier type, is of high class construction and the body capacity will not affect the tuning of the instrument.

THE SENSATION OF THE SHOWS

Enco B Batteries

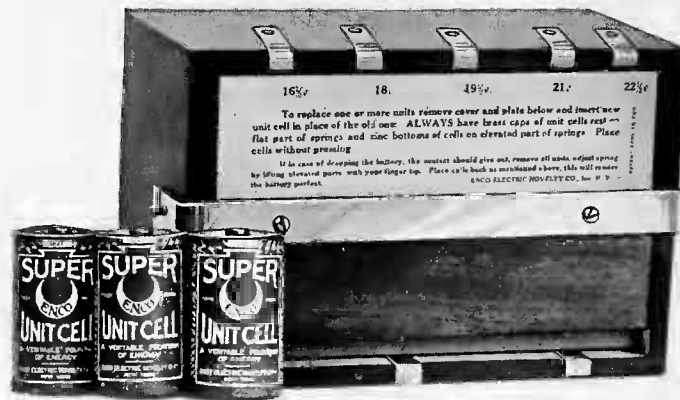

**Do Away
with
Waste**

Refillable with
standard flashlight
unit cells.

A single unit cell
may save the cost of
a new battery.

Dealers write for
proposition in your
territory

ENCO ELECTRIC NOVELTY CO., Inc.

Manufacturers of Standard and Refillable Batteries
603 West 130th Street

New York, N. Y.

P. & E. BREWER RADIO CO., Inc.

Manufacturers and Wholesalers

"PEBRACO"

RECEIVING SETS

**High-Grade Crystal Sets in Two Sizes
Multi-Wave Audion Tuning Sets**

DEALERS—Write for Our Proposition TODAY

62 GREENWICH AVENUE

NEW YORK CITY

Phone: Chelsea 7059

WE MANUFACTURE FIBRE SPOOLS

For spooling small quantity packages of Magnet Wire
for the retail trade.

PRICES: { \$34.00 per 1,000, 1/4 lb.
36.00 " 1,000, 1/2 " f. o. b., Jersey City
44.00 " 1,000, 1 "

10% discount on orders for 1000 of a size.

TRIAL ORDERS OF 100 OR MORE SOLICITED

FORNEY FIBRE CO.,

97 BOYD AVE., JERSEY CITY, N. J.

NEAT CRYSTAL SET

A crystal detector set that has a very attractive appearance is made by the Klein Electric Manufacturing Company, of 67 Spring Street, New York. This set, which the makers call the Klein Conductor, is one of the few on the market which has some uniformity in its construction, and which does not resemble a hodge-podge of odds and ends.

The specifications of this set, which is assembled ready for sale, are furnished complete with crystal and posts, for receivers and grounds alike, together with wiring instructions. The feature of the set is the fixed condenser of .002 mfd. capacity. The list price for the conductor complete with the condenser is \$2.00. The set is also sold without the condenser at \$1.50 list.

The Klein Electric Manufacturing Company also sell their amplisite crystals, and a line of tuning coils, variable condensers, rheostats and switches.

EMELOID DIALS

The Emeloid Co., Inc., of Brooklyn, is manufacturing dials which come in three sizes, 2, 3 and 4-inch. These dials are unbreakable, have a permanently high lustre and practically eliminate hand induction. They have been laboratory tested by some of the largest manufacturers of radio sets and the *Evening Mail*, and have been found to be satisfactory in every way.

The Emeloid dials are listed at from 35 cents to 60 cents.

This makes the dial a price proposition.

The Emeloid Co., Inc., also manufactures spools for magnet coils for head sets, ear pieces for head sets. Their ear pieces can be made in white or ivory colors, with a high polish which gives them a distinction of being sanitary and of very fine appearance. They solicit any kind of special work along these lines and are fully equipped to do moulding, stamping, cutting, printing, embossing, etc.

READY TO MAKE PARTS

The Autoscrew Company announces that they are ready to manufacture the following to customers' specifications:

Screws of all kinds, washers, nuts, stampings, tools, jigs and dies, special turned parts of all metals, shafts for condensers and spacing washers.

Benjamin Levi is the president of the company, and the keynote of the organization is "accuracy." It also engages in experimental work for clients.

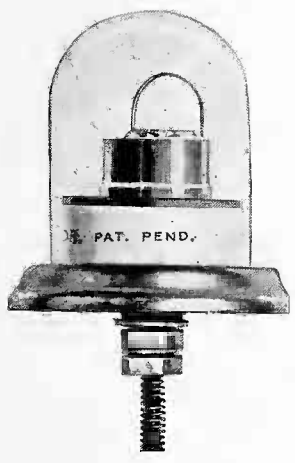

STATIC WON'T BOTHER YOU NOW

IN USING
THE "GREWOL"
RADIO DETECTOR

All Troubles Are Eliminated
This Detector Is Always Set and Ready
LIST PRICE, \$2.00
Write for Proposition.

RANDEL WIRELESS CO.
9 CENTRAL AVENUE, NEWARK, N. J.
Sole United States Distributors

(Actual Size)

MODERN



TRADE MARK

Established 1911

Territory now being allotted to jobbers and dealers desiring to handle ONLY high grade guaranteed radio equipment.

Write at once for full information.

L. P. HORNING, JR.
EXPERIMENTAL LABORATORIES
Distributors for "Modern" Radio Apparatus
ELIZABETH TRUST COMPANY BLDG.
Elizabeth, New Jersey



TRU-TONE

PRODUCTS

A Real Spark in Radio

IS YOUR GUARANTEE

for

HEAD SETS—3000 AND 4000 OHMS
CRYSTAL SETS WITH PHONES—PROTECTOR, ETC.
NON-REGENERATIVE TUNERS AND DETECTOR.
RADIO AND AUDIO FREQUENCY
ONE—TWO—THREE STEP AMPLIFIERS

Catalogues to

JOBBER—DEALER—DIRECT

Manufactured by

INTERSTATE RADIO CORP.

16-18 West 22nd St. New York, N. Y.

Book Review

By BERNARD JEROME FARRELL

The Editors of the RADIO DEALER will be glad to review new publications in this field as they may be issued. Address them attention BOOK REVIEW EDITOR, the RADIO DEALER, 1133 Broadway, New York City.

The Radio Library. Vol. 1.—The Radio Publishing Co., Pittsburgh, Pa.

“In publishing this book, it is the plan of the authors to put into your hands little by little a complete, concise and non-technical survey of Radio Science. Mathematical formulae and complicated theories will be simplified and you will be taught how to construct and operate radio apparatus in a manner that will give you the most efficient results.—THE EDITORS.”

The Editors have indeed carried out their plan in so far as Volume One is concerned. Starting with a brief history of Radio Telegraphy it passes into the elementary theory of Wireless Telegraphy, explanation of Radio symbols used in standard drawings, and definitions of common terms. Those who have been seeking a good and efficient method of learning the “code” will find the chapter on The International Code worth the cost of the volume. It is true that many amateurs, especially those who have entered the field since the advent of broadcasting, believe that a great amount of work is entailed in the study of the radio code. Such is not the case, and it is believed that all such fears will be dispelled after reading over this chapter.

The balance of the book is devoted to a brief explanation of transmitting and receiving equipment, and a thorough and detailed description of the antennae, crystal detectors, condensers and telephone receivers.

The Radio Publishing Co. has given to the public a book that will meet with the whole hearted approval of those who have just entered the radio field and those who have been enthusiasts for some months. It is different from anything that has come to our attention thus far and novel in that it gives its “lessons” in small doses. That, without a doubt, is the ideal way of studying any course. We await with interest the coming of Volume Two and feel sure that everyone who reads the first volume will share that same interest.



EMELOID DIALS—2"—3"—4"
 2" 35c—3" 50c—4" 60c
 MANUFACTURERS—JOBBER—DEALERS
 WRITE FOR DISCOUNTS
 EMELOID CO., INC., 536 JUNIUS ST., BROOKLYN, N. Y.

THE PARAGON
Audio-Frequency Amplifier TRANSFORMER
 has been produced as a radio telephone amplifier transformer which reduces tone distortion and eliminates scratching, hissing or shallow tones.
 This is accomplished by the free use of high grade silicon steel in the laminated core, the provision of a magnetic field which is practically perfect and the careful proportioning of the windings.
 May be mounted on either panel or base. Occupies a minimum space and is readily accessible.
 List Price \$5.00
 LIBERAL DISCOUNTS TO DEALERS
E. M. WILSON & SON
 11 Lafayette Street, at Broad, Newark, N. J.
 Phone: Market 0714

JOBBER GET OUR PROPOSITION ON THIS DEPENDABLE

TASCO
CRYSTAL RECEIVING SET



An efficient set that will receive as well as any higher priced Crystal Detector set on the market.

ABSOLUTELY GUARANTEED

IMMEDIATE DELIVERIES

\$12
COMPLETE

DEALERS—If your Jobber doesn't handle this set write to us.
 Complete with pair of phones..... \$12.00
 Receiving set only..... 5.00
 Pair of Tasco phones..... 7.00

THE AUTOMOTIVE SPECIALTY CORP.
 311 West 59th Street New York City, N. Y.

AMATEUR RADIO. Maurice J. Grainger. 50 cents. 160 pp. The James A. McCann Company, New York.

It is a sign of the times that a book on radio should be printed in paper covers. Paper-backed books are usually associated with cheap romances or dime novels. Yet here is a modest book, neatly printed, and without any of the gaudy fixtures of a less worthy publication. This means nothing more nor less than that the boy of today is no longer interested in Nick Carter or Young Wild West but in the scientific adventures to be found in Radio.

The author of "Amateur Radio" is admittedly writing for these boys who have sworn their new allegiance to Science and Radio. His book takes them back to the very beginnings of the modern miracle, explaining to them the meaning of radio waves and their origin, of electricity and the part it plays in Radio, and of magnetism. With this background in their possession, he then shows them how to build their first crystal set.

He simplifies the construction of such a set wonderfully. There is no doubt that any boy or man of average intelligence may become conversant with the rudiments of Radio by reading these first chapters, which form only a part of Mr. Grainger's book. He then proceeds to the construction of a vacuum tube set and it is part of his technique to explain Radio more fully while describing the making of the V. T. set.

On the whole the book is readable and decidedly instructive. It leads the reader on with the desire it kindles to know more about the wonder of modern Science. It is always clear, and decidedly suitable for the field which it intends to cover.

The James A. McCann Company are to be congratulated for publishing the book.

COMPLETE RADIO RECEIVER, THE BEGINNER'S HANDBOOK. Murray Elliott, 25 cents. E. J. Hendrickson Company, New York.

The new edition of the "Complete Radio Receiver, the Beginner's Handbook," published by the E. J. Hendrickson Company of New York, which is just off the press, contains new additions to the illustrations and some revisions of the text.

A list at the back of the handbook contains the names, location and wave lengths of approximately 200 broadcasting stations within the United States.

The book is proving one of the "best sellers" in the radio field.

COMPLETE NON-AERIAL PLUG

A complete plug and five feet of cord to supplant the outside aerial is manufactured by the Roydart Company, Incorporated, of 2 Rector Street, New York City.

This "Roydart" plug is suitable on the electric light circuit of the home or apartment. Electric light mains are

positive and negative and for lighting purposes it is immaterial how the mains are connected in the lamp socket. Therefore, one wire connection from the lamp socket may connect different leads in different lamp sockets. "Roydart" selective plug permits selecting the wire giving best result by simply turning the switch. The list price is \$2.00.

WHY EXPERIMENT—MR. MANUFACTURER?

For years we have been cutting, drilling, machining, grain-ing and polishing Bakelite Dilecto.

Put this experience to work on your panels. Write us for proposition and sample.

STANDARD WIRELESS PANEL COMPANY

49 MECHANIC STREET

NEWARK, N. J.

JOBBERS—DEALERS!

THE POPULAR PRICED
VACUUM TUBE TUNER AND DETECTOR
IS OUT ON THE MARKET

\$25.00 LIST

300 MILE RANGE—OUR SPECIAL CIRCUIT
In cherry cabinet—unscratchable finish—rubber panel

HOW MANY?

Excellent proposition with exclusive territory to recognized jobbers

RADIO CO. OF BOSTON, 161 Milk St., Boston, Mass.



R-Cob No. 10
\$25.00

**AMATEUR
RADIO**



How and Why of Wireless with Complete Instructions on Operation of Receiving Outfits
by
Maurice J. Grainger
Radio Expert formerly with The Westinghouse Electric and Mfg. Co. and the United States Navy

MORE CUSTOMERS

What are you doing to make more Radio fans?

HERE'S A WAY

Distribute
The best book on the market

AMATEUR RADIO

by
Maurice J. Grainger

Radio Expert formerly with the Westinghouse Electric & Mfg. Co. and the United States Navy.

184 pages—150 illustrations
Full size book for 50 cents
Cloth, \$1.00

SELLS UPON SIGHT

LIBERAL DISCOUNTS TO
JOBBERS AND RETAILERS

THE JAMES A. McCANN COMPANY
188-192 West 4th Street New York

GIVES RADIO PRIZES

The "Wichita (Kansas) Eagle" is offering a well-known make of receiving set as a prize to boys and girls for obtaining new subscriptions.

Richard Barthelmess, film actor and star of "Tol'able David," is one of the firm of the Dolith Radio Mfg. Co. of New York City. The company, which was recently incorporated, makes crystal sets.

SPAGHETTI FOR IMMEDIATE DELIVERY

Smooth, Heavily Coated, Flexible, Woven Tubing of Great Dielectric Strength and is Without an Equal as an Insulator. Black or Yellow in

10,000 ft. lots.....	.03
5,000 " ".....	.0325
1,000 " ".....	.0350
500 " ".....	.0375
Less than 500.....	.0425

SAMPLES UPON REQUEST

JEWEL RADIO CO.

1114 S. Michigan Ave. Chicago, Ill.

NOTE TO THE TRADE:

Quote us prices, terms, discounts and deliveries

WE ARE DISTRIBUTORS exclusively via mail order

Complete sets
Radio Equipment
SPECIALTIES

Manufacturers

Desirous of New York Representation communicate at once

RADIO EQUIPMENT
SERVICE

500 FIFTH AVENUE
NEW YORK CITY

Trade - Mark Department

Conducted by Chauncey P. Carter, Trade-mark Specialist of Washington, D. C.

RADIO TRADE-MARKS

CLIMAX—Jewett Manufacturing Corporation, Newark, N. J., August 20, 1921.

AEROPHONE—Essex Specialty Co., Berkeley Heights, N. J., March 2, 1922.

MINIVOX }
AMPLIVOX } The Magnavox
RADIOVOX } Company Oak-
ELECTROVOX } land, California,
March 1, 1922.

MORSEOPHONE—Morse Mfg. Co., Inc., Newark, N. J., March 31, 1922.

AERIO LA SR.—Westinghouse Electric & Mfg. Co., East Pittsburgh, Pa., Dec. 20, 1921.

NUMBERED LIST OF PARTS

The Whitall Radio Company, of Springfield, Mass., are issuing to their dealers for customer's use an interesting little catalogue of Radio apparatus and parts.

The Whitall Company is evidently grounding itself deep in the Radio trade, for each piece of apparatus listed in the catalogue is numbered, so that all the customer has to do to order a Signal No. R25 Arlington Transformer is to write 151. Or if he wants a Clapp-Eastman type of receiving set, H. R. Regenerative Receiver, he writes for number 533.

There are almost one thousand parts listed in the Whitall catalogue, which demonstrates the remarkable growth and service that are becoming synonymous with the name of Radio. The Whitall firm are distributors for Clapp-Eastman, Radio Corporation of America, Magnavox, Baldwin Radio Company, Federal Telephone and Telegraph, and others.

The catalogue also contains interesting information for the radio enthusiast, together with a list of broadcasting stations and the international code.

DO YOU WANT CATALOGS?

Retailers and jobbers who desire to be placed on the mailing list of manufacturers, for new prices, etc., are invited to send their names to the RADIO DEALER, Service Bureau. No charge for listing under this heading.

Variable Condensers

Variable condensers to be efficient must be well made. Loose joints or faulty construction soon allows the plates to get out of alignment and decrease their efficiency.

A seasoned organization backed by a half million dollar equipment have placed the United Condensers in the front rank with radio engineers the country over.

Prices—43 plate,	\$4.50
23 " "	4.30
11 " "	4.00

without dial or knob.

Liberal discounts to jobbers and dealers.

We invite correspondence with Radio Manufacturers who are interested in using our facilities and services for manufacturing Radio Equipment.

United Mfg. and
Distributing Co.

536 Lake Shore Drive Chicago, Ill.

INDOOR AERIAL PLUG

The passing of the outdoor aerials is an event that will not be mourned by very many. The antenna has always been unpopular with the real radio fan. His mother was afraid of it, dad was against it, and the landlord positively forbade it. Necessity became the mother of invention, and all of the inventive genius of the radio business was called to task, and soon all forms of substitutes began to appear.

One of the most successful substitutes is the Racony Plug—the plug with the fourteen variations. The Racony Plug is guaranteed to work equally as well on direct or alternating current. As a matter of fact no current at all is needed. The makers advertise “put the plug in your nearest electric light socket and tune in.” The Radio Company of New York, the manufacturers of the Racony Plug, have faith enough in their product to sell it on a money back basis.

A. Baile Hutton, Gaston & Co. and the Friedgold Co. are the distributors for the Racony Plug, which is being nationally advertised in the leading radio papers throughout the United States.

E. B. OVERSHINER INVENTS RECEIVER

E. B. Overshiner, who is president of the General Radio Equipment Company of Chicago, is the originator and inventor of the receiver they are now marketing and has been developing 'phone headpieces for the past twenty-five years.

Reginald A. Fessenden, who is an authority on radio, in the Government service, approved and used the Overshiner 'phone fifteen years ago.

During the war Mr. Overshiner made carloads of equipment for the Government for the Signal Service Department.

In addition to his other activities Mr. Overshiner is president of the Swedish-American Telephone Co.; president of the Dominion Telephone Mfg. Co., of Canada, as well as vice-president and chairman of the Executive Committee of the Electrical Trades Exhibition of Chicago, for the past five years.

The General Radio Equipment Co. 'phone is well made, as might be imagined, and has the endorsement of many practical radio men.

Dealers who sell this 'phone can advertise its real value.

Radio dealers who mention THE RADIO DEALER in writing to RADIO DEALER advertisers will be doing us a favor.

Positive Contact **COMPRESSED, BAKED, SEALED** **Permanent Capacity**

KAPACITON

INDIVIDUALLY TESTED

KONDENSERS

ARE BETTER CONDENSERS!

Phone * Grid * Grid with fixed leak * Grid with detachable and variable leak. (Pat. Pen.)

A CUSTOMER—FOR—ONCE or
“FOR KEEPS” ?

It's entirely in your hand to have either sort—the customer who comes in once and swears “NEVER AGAIN,” or the customer who enthusiastically keeps coming and grows into a valuable asset.

Dealers tell us KAPACITONS make repeat customers. Certainly, they build a buyer's confidence in you. To begin with, a KAPACITON is a technical product, not a toy or a makeshift. We've been making the best electrical insulations for over a decade. We make the best condensers now.

When better ones are made, we'll make them

KAPACITONS have positive contact through continuous copper foil, UNIFORM KAPACITY through being compressed to a definite thickness, PERMANENT CAPACITY through being baked and sealed; KAPACITONS are individually tested. They improve reception and eliminate those noises which are directly caused by a loosely wound condenser without continuous foil. KAPACITONS are moderately priced and allow the dealer a fair profit.

That's why they are

SOLD BY THE BEST JOBBERS AND DEALERS!

Established 1910

Jersey City, N. J.

THE PORTABLOOP



The only practical antenna for apartments, offices and congested districts.

Order a sample now.
\$10.00 List.



212 Central Avenue

Some Patent Facts

Does a New Invention Have to Be All New?

By FRED H. BOWERSOCK
In the "New York Times"

I doubt very much if there is a single member of the so-called patent bar—or, so far as that is concerned, any one else conversant with patents, the mode of their procurement and the uncertainty of the protection afforded thereby—who would contend that manifold "patent law weaknesses" do not exist, but the patent laws are not so weak as some lawyers allege.

One lawyer has said: "There are thousands of patents which have been granted many years ago which have never been commercialized, particularly having mechanical elements as their basis, which parts of such mechanical elements may in these later days be used to advantage in conjunction with improvements. Such a mechanical element or the whole device, at the period when the patent was granted, may then have been impractical for the purpose for which it was patented, but which patent, or element of which, in conjunction with improvements made today, with our changing conditions, might be very profitably commercialized." This is all undoubtedly true. "But," this lawyer continues, "by reason of that element or device already having been patented, even though the patent had expired, cannot be incorporated with the improvement of the later day, and claims secured therefor, thus discouraging the laterday inventor, in that he is unable to perhaps secure a strong or 'merchantable' patent on the perfected device."

An article, device or machine, to be patentable, must be "new and useful," but this does not mean that every element entering into the composition of the whole must be the creation of the inventor. It is inconceivable that any machine successfully operable for any useful purpose could be constructed without the utilization of mechanical principles and means for carrying them into practical effect both of which were old and probably well known—possibly at one time covered by a patent or patents—long prior to conception of the real invention embodied in the improved machine. It is not even necessary that the combination which constitutes the machine include a single new element, for it is a well settled principle of patent law that "a new combination of old ele-

RECEIVERS REWOUND AND REPAIRED

Any make, copper wire, any resistance
Work guaranteed
Commissions to Dealers

MONTCLAIR RADIO CO.
272 Bloomfield Avenue Montclair, N. J.

ELCO RADIO SUPPLY CO.

Manufacturers'
Distributors

2728 Broadway, New York City

Moss Radio Company

Jobbers in

Radio Sets and Equipments

202 West 23rd Street

New York City

Phone Watkins 5078

WANTED

Jobbers and Distributors

We are manufacturing a Combination Rheostat-Audion Bulb Socket easily fastened inside to the panel, including neat controlling Rheostat knob. All furnished as one Unit. List price, \$2.20.

We will also furnish prices and photos on our latest type of Skeleton Variometers on Moulded Base, and Receiving Sets selling from \$5 up.

Ajax Radio Corporation

536 So. 10th Street

NEWARK, N. J.

ments which produces a new and useful result is patentable."

If in the construction of an improved machine it is necessary to incorporate therein a part or parts which in themselves are covered by an unexpired patent to another, the improved machine—if the improvement amounts to invention—would still be patentable, although not capable of commercialization in view of the fact that it could not be made, sold or used without infringement of the earlier patent if the latter were valid and the invention properly claimed therein. But the disclosures of any expired patent may be utilized, in whole or in part, in the construction of a machine which constitutes a real improvement, and the latter as a whole may be made the subject of a "merchantable" as well as a strong and valid patent.

ENTER RADIO FIELD

The Automotive Specialties Company, of New York, whose products have been known in the automobile accessory field for a number of years under the "Tasco" trade-mark, have recently undertaken the manufacture of a popularly priced crystal receiving set and high quality headset.

All "Tasco" products carry the unreserved guarantee of the Automotive Specialties Company. The receiving set lists at \$5.00, while a pair of "Tasco" phones retail at \$7.00. The quality of former "Tasco" products in the auto accessory field is doing much to entrench their products firmly in the radio market.

WARRANT LOOSE COUPLER

The Mercury Radio Company, of Orange, New Jersey, guarantee their loose coupler designed especially for radio service by their engineers, after painstaking experimenting.

The particular feature of their loose coupler is that its tuning coil core is made of bakelite, peculiarly adapted to radio needs.

The Company also makes radio sets and the units of the sets, which may be built up as the enthusiast finds his wants and his pocketbook increase.

All Buffalo newspapers have arranged to supply the evening programs of the new radio broadcasting station, WRG, of the Federal Telegraph and Telephone Company, which was opened May 21. The Courier has the Monday night program; News, Tuesday night; Times, Wednesday night; Express, Thursday night; Commercial, Friday night, and Enquirer, Saturday night.

The Edmonton Journal, Edmonton, Alberta, is the latest Canadian daily to announce the installation of a radio broadcasting station.

DEALERS ATTENTION

We are ready to market an attractive line of Radio Sets and Accessories. Communicate with us regarding exclusive selling rights for your territory.

Roydart Company Inc.
2 Rector Street New York City

"SEABOARD" Products

Sturdy Construction

Perfect Insulation

Special Shaft Contact

Adjusted, Tested and Inspected Before Shipment

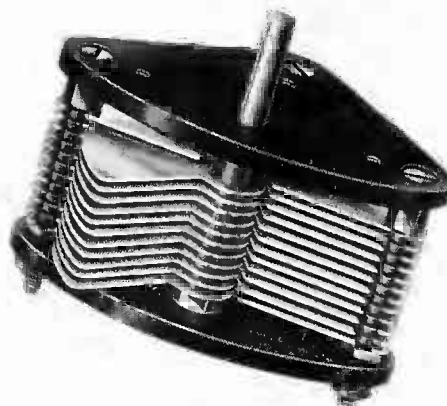

23 Plates

Capacity—.0005 mfd.

Dependable Efficient

Guaranteed Low Price

PRICE \$3.00

No. 1. Variable Condenser
For Panel Mounting
IMMEDIATE DELIVERY

Jobbers and Dealers

Write for Discounts

SEABOARD RADIO CORPORATION

266 Grand Street, New York City

TONKS VARIABLE CONDENSERS

Every condenser tested before leaving factory and guaranteed to function properly

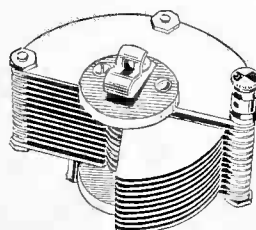

Air Type

13 plate—.00025—\$3.00

23 plate—.0005—3.50

43 plate—.001—4.25

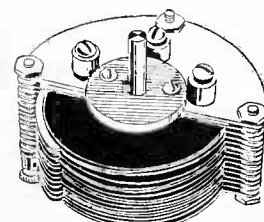

Insulated Type

Ideal for Amateurs

13 plate—.0005—\$3.40

25 plate—.001—4.00

Distributers Write

Only One Wanted in Each Territory

TONKS MFG. CO.



16-22 BOYDEN PLACE
NEWARK, N. J.

IMMEDIATE DELIVERY	
CABINETS—	PANELS—
Imitation Mahog- any or Flemish Oak Finish	Genuine Formica, 3/16" thick
6 x 7 x 10	6 x 10 1/2
6 x 7 x 13 1/2	6 x 14
6 x 7 x 20 1/2	6 x 21
Other Sizes to Order	
COMPLETE RECEIVING SETS	
Jobbers and Dealers Get Our Discounts	
THE MIHO COMPANY	
8 East Third St.	Cincinnati, Ohio

Ask Our Service Bureau



To Reduce Tube Whistling

Tubes howl and whistle if the condenser of the receiving set fluctuates in capacity.

Dubilier Micadons are permanent in capacity. Hence, they prevent the tube noises due to poor condenser construction.

Dubilier Micadons are fully protected by patents granted in 1920. To make sure that you are buying a mica condenser of permanent capacity—one that will not burn out and that will not cause tubes to howl—order *Micadons*.

Micadons are made in two types—type 600 and type 601.

Micadon Type 600 is supplied in capacities varying from .0001 to .005 mfd. with and without grid-leak mountings. Retail price 75 cents to \$1.00 each.



Micadon Type 601 is supplied in capacities varying from .0001 to .0025 mfd. Retail price 35 cents to 40 cents each.

Liberal discounts to the trade.

In order to meet the demand we are increasing our production facilities.

We also manufacture other types of condensers for transmitting and receiving.

DUBILIER CONDENSER and RADIO CORPORATION

Department R D

217-219 CENTRE ST. NEW YORK

Branch Office: Munsey Building, Washington, D. C.

Jersey Paper Broadcasts High Class Programme

Station WAAT, the radio broadcasting station of the *Jersey Review*, located at Jersey City, while not one of the really high powered stations, is one that is very well known to radio operators of the east.

Station 2-IA, the former call of WAAT, is the outgrowth of a spark station well known to old time radio operators. It has been in operation for years. Frank V. Bremer, Radio Editor of the *Jersey Review*, built this set back in the "dark ages" of radio; that is, before the advent of the vacuum tube which made voice transmission possible.

On January 11, 1921, the first sending of voice was done by Mr. Bremer, and exactly one year later, January 11, 1922, the first broadcasting program was sent out by the *Jersey Review*. At that time station 2-IA operated at 210 meters wave length.

Regular semi-weekly programs have been broadcasted from this station since that date. When the ban was placed on broadcasting at 200 meters, the *Review* call was changed to WAAT and the wave length to that allotted to limited commercial stations.

During the winter months programs from WAAT were heard at Memphis, Tenn., Owensboro, Ky., Toronto, Can., Calais, Me., by the Cunard S.S. *Caronia*, 450 miles outside New York Harbor, and in many other distant places. These results are remarkable when it is considered that station WAAT operates on 2 five watt tubes as oscillators, 2 five watt tubes as modulators, and one five watt tube as speech amplifier.

Station WAAT is ideally located for radio transmission. It is 175 feet above sea level, located on the lower end of the historic Palisade Mountain Ridge.

Because of the fact that programs are only broadcasted Wednesday and Sunday evenings the quality of the entertainment provided is kept to the highest quality possible. On Wednesday the program is usually an address by some nationally known person. Addresses are limited to fifteen minutes. Following the speaker an hour program of operatic or concert numbers are radiated. This is sometimes varied by an evening of dance music, and on two occasions "radio parties," to which artists that had been particularly well received, were invited, and each contributed something toward the enjoyment of the invisible audience.

Among the prominent instrumentalists that have delighted WAAT audiences are, Alexander DuBruille, noted French violinist; Harold Berkeley, English concert violinist; Anna Klomburg, violinist; and Gerald Reidy, well known violinist. Prominent among the vocalists on past programs are Adele Rankin, coloratura soprano, former member of the Aborn Opera Co.; Louis Chartier, French baritone well known for the records he records for the Victor Co.; Elsie Baird, coloratura soprano and America's leading singer of Japanese music, also a Victor artist; The famous Jersey City Police Quartette; Eleanor Patterson, concert contralto; Alexander Trousenoff, Russian tenor; Pietro Soldano, Italian baritone; Hazel Simonson, dramatic soprano; and many others. Russell Levy, Dr. J. B. Bruns, George Ponzoni, Grover Tilden Davis, and James P. Dunn are prominent among the well known pianists and composers who have been at station WAAT.

Programs on Sunday include thirty minute radio chapel vespér service, with sacred music, following which a concert program is broadcasted.

Many of the most prominent clergymen of the east have conducted the chapel services at WAAT.

The first Salvation Army service to be broadcasted was sent from WAAT, while the first program of chamber music ensemble was played at WAAT by the Symphony Society of New Jersey.

The *Jersey Review* was one of the first papers to devote space to the subject of radio, and has conducted a special radio page since last December. During the recent conference of Broadcasters of the Second District Mr. C. J. Ingram, managing editor of the *Review*, attended the sessions and contributed toward the drawing up of the agreement under which the stations are soon to operate. The newly organized Radio Broadcasting Society of America, because of the great interest shown by the *Review* in the new science, recently elected Mr. Ingram vice president.

SIoux FALLS NOTE

The Sioux Falls (S. D.) Argus-Leader is installing a radio broadcasting station, which it expects will be in operation by the middle of June.

DISTANCE TUBE SET AT LOW PRICE

The Machti Radio Company of Boston, Massachusetts, have just placed on the market a very efficient single tube set that retails for \$25.

This set is mounted on either of two panels, the purchaser having the option. One panel is made of polished hard rubber, and the other panel on which the set is mounted is of a special Machti composition, which the Machti Company have themselves developed, and which is said to surpass in every way the panel material now on the market.

With this simple low-price set, the Machti Company have tuned in from their Boston factory on concerts and speeches as far away as Newark, New Jersey, and Schenectady, New York.

HAS COMPREHENSIVE LIST

The United Radio Sales Corporation, of Boston, Massachusetts, distributors for Westinghouse, General Electric, G. Brandes, Incorporated, and others, are issuing a very attractive and comprehensive catalogue of Radio supplies. It is more than the usual list of radio parts, for it contains valuable information for the radio dealer, as well as a dictionary of wireless terms.

Among the products listed in the United Radio Sales catalogue are "Cleartone" loud speakers, Westinghouse detectors, General Electric Regenerative sets, and Wireless Special Crystal Receivers.

The company is featuring a special Vacuum Tube socket, made of bakelite, with contacts of phosphor bronze and nickel-plated binding posts. The "Couch" head set is another of the company's star lines. The original qualities of this set include a light weight of only eleven ounces, and special patent one hand adjustment. The head set lists at \$8.00.

Finally, there is the United Home Radio Antenna outfit, complete for setting up at a list price of \$6.50. This includes 125 feet of antenna wire, 2 antenna insulators, 2 screw eyes, 50 lead-in wire, 3 porcelain knob, entrance insulator, antenna protector, 30 feet ground wire, ground clamp and a dozen insulated staples.

The Kansas City Star last week opened its new radio broadcasting station, the call of which is WDAF.

The Salt Lake Telegram has installed a radiophone station and is giving away receiving sets as premiums.

HERE'S REAL RADIO SERVICE!

THE Radio Supplies you want WHEN YOU WANT THEM! IMMEDIATE DELIVERIES our motto.

The most comprehensive stock of Radio supplies in America. Get into it right, to make your success in the Radio field brighter and easier!

Complete lines of A. B. C., Lyradion, Pennsylvania Wireless Regenerative Receivers, Atwater Kent, Penn Radio, Bel-Echo, Electrore Mfg. Co., Homecharger, Continental Fibre Co., General Apparatus, etc., etc.

G. A. One Stage Amplifier, Laboratory Type
A. B. C. Two Stage Amplifier No. 5014
G. A. Three Stage Radio Frequency Amplifier
Lightning Arresters (Brach)
A. B. C. 27 Volt Battery
No. 1—Insulated Binding Post
No. 2—Insulated Binding Post
No. 3—Nickel Brass Binding Posts
No. 4—Nickel Brass Binding Posts
COILS, HONEYCOMB A. B. C.
Mounted B. L. No. 25 to 1250
National Moulded Phone Condenser .003 MFD.
No. 650—3 Variable Condenser A. B. C.
No. 650—11 Variable Condenser A. B. C.
No. 650—21 Variable Condenser A. B. C.
No. 650—43 Variable Condenser A. B. C.
No. 800 A. B. C. Three Capacity Grid Condenser
No. 1 G. Grid Condenser
No. 2 G. L. Grid Leak Condenser
No. 3 P. Phone Condenser
Mounted Galena Crystals
Mounted Goldite Crystals
Unmounted Galena Crystals
Unmounted Goldite Crystals
 $\frac{1}{4}$ " x $\frac{1}{4}$ " Contacts and Nuts No. 56
 $\frac{1}{4}$ " x $\frac{1}{8}$ " Contacts and Nuts No. 57
 $\frac{1}{4}$ " x $\frac{3}{16}$ " Contacts and Nuts No. 58
 $\frac{3}{16}$ " x $\frac{3}{16}$ " Contacts and Nuts No. 59
 $\frac{3}{16}$ " x $\frac{1}{8}$ " Contacts and Nuts No. 60
Fidelity Crystal Detector
G. A. Laboratory Type Detector
A. B. C. Detector and 1 Stage Amplifier No. 5013
G. A. Laboratory Detector and 2 Stage Amplifier
G. A. Detector and 2 Stage Semi-Finish
3" Electrore Dial $\frac{1}{4}$ " Shaft No. 506
3" No. 670 A. B. C. Metal Dial
4" Electrore Dial $\frac{1}{4}$ " Shaft No. 508
3" Moulded Dial $\frac{3}{16}$ " Shaft No. 510
 $3\frac{7}{8}$ " Moulded Dial $\frac{1}{4}$ " Shaft No. 514
3" German Silver Dial $\frac{3}{16}$ " Shaft No. 516
3" German Silver Dial $\frac{1}{4}$ " Shaft No. 518
Homecharger No. 5144 C
Ball Insulators No. 4500 Electrore
Baby Insulators No. 4501 Electrore
7" Insulators No. 4507 Electrore

Jensen Single Circuit Jack No. 350
Jensen Closed Circuit Jack No. 351
Jensen Double Circuit Jack No. 352
Jensen Single Circuit Filament Control No. 353
Jensen Double Circuit Filament Control No. 354
A. B. C. No. 5005 Loud Speaker
No. 753 Two Coil Mounting A. B. C.
No. 754 Three Coil Mounting A. B. C.
Bakelite Panels
 $\frac{3}{16}$ x 6 x 8 Smooth edged
 $\frac{3}{16}$ x 6 x 12 Smooth edged
 $\frac{3}{16}$ x 6 x 16 Smooth edged
 $\frac{3}{16}$ x 12 x 18 Smooth edged
Jensen Round Plug
No. 5010 A. B. C. Crystal Receiver
G. A. 150-600 Semi-Finish Receiver
G. A. 150-2600 Semi-Finish Receiver
Tuska No. 224 Receiver
A. B. C. Rheostat No. 1125
G. A. Rheostat
Slider Rods $\frac{3}{16}$ x $\frac{3}{16}$ x 8"
Slider Rods $\frac{3}{16}$ x $\frac{3}{16}$ x 10"
Slider Rods $\frac{1}{4}$ x $\frac{1}{4}$ x 8"
Slider Rods $\frac{1}{4}$ x $\frac{1}{4}$ x 10"
 $\frac{3}{16}$ " Brass Sliders No. 875
 $\frac{1}{4}$ " Brass Sliders No. 876
V. T. Single Sockets
V. T. Double Sockets
National Moulded Socket
Switch Stops Nickeled No. 975
Rotary Switches $1\frac{3}{8}$ " No. 95 (National)
Anti-Capacity Switch Jensen
Firco-Clad Amplifier Transformer
G. A. Radio Frequency Transformer
Bel-Echo Telephones 2200 Ohms
Party Phone
Cambric Tubing No. 14
Atwater Kent Variometer
Atwater Kent Variocoupler
A. P. Detector Tubes
A. P. Amplifier Tubes
No. 14 Solid Copper Wire 100 ft. Coil
7-22 Stranded Copper Wire 100 ft. Coil
7-22 Tinned Copper Wire 100 ft. Coil

Dealers, Write or Wire Today for Catalog 101A

Pittsburgh Radio Supply House

BELL TELEPHONE, GRANT 3632

963 LIBERTY AVENUE

PITTSBURGH, PA.

New York to be Fall Scene of International Show

Plans for the First International Exposition to be held in New York are being developed by a committee of the American Radio Exposition Company which was recently incorporated under the laws of the State of Delaware.

Thousands of square feet of space have been leased in the Grand Central Palace, and, although the exposition is several months away, the committee is already laying out plans for the installation of equipment, including a big broadcasting station on the roof of the Palace, and developing a program of daily activities of wide appeal to radio fans.

Leading radio manufacturers will exhibit samples of their equipment. It is expected every known make of instrument will be on view, along with many home-made receiving sets, be-

longing to amateurs, miniature outfits of many kinds and other examples of the handiwork of ingenious amateurs.

Dealers, engineers and inventors are also invited to participate in the exposition, which is intended to depict the rapid growth of the industry and to demonstrate the infinite possibilities of expansion beyond its present development. The committee announces it will welcome any suggestions which will help make the exposition the most notable radio show of the industry's brief history.

George Brokaw Compton is chairman of the Committee, which has headquarters in No. 120 Broadway. All communications and suggestions or requests for information should be addressed to him.

NEW FORM OF CATALOGUE

A departure in service to dealers has been undertaken by the American Radio and Research Corporation of Medford Hillside, Mass. This is in the form of monthly bulletins sent to each dealer, who puts them in a binder which the "Amrad" people have already sent him.

The binder itself is neat and practical, and being of stout paper will last indefinitely. The bulletins sent out monthly deal with the "Amrad" products of the company. This is of decided service to the dealers, for, in the changing market of the Radio Industry today, price fluctuations tend to make the annual or semi-annual catalogue or price list soon out of date.

The bulletins, beside giving prices, explain very carefully each new "Amrad" product, what it is, what it does, how it can best be used, and the like. Besides, the bulletins contain such articles as "How to build up, step by step, a successful receiving station."

BROOKLYN FIRM OPENS

The Specialty Service Company, of Brooklyn, began operations last week as manufacturers of a complete line of transmitting and receiving equipment and parts. The office of the company is at corner Fourth Street and Pacific Avenue, one block from the Long Island Railway station.

With the Specialty Service Company is associated a well-known

Brooklyn Radio figure, Frank A. Maher, who is known just as well by his code number 2RM. Mr. Maher will have charge of the company's radio sales department, and will be in an excellent position to look after the wants of the radio trade in view of his past experience. The products of the new company will bear the imprint "RiteRadio."

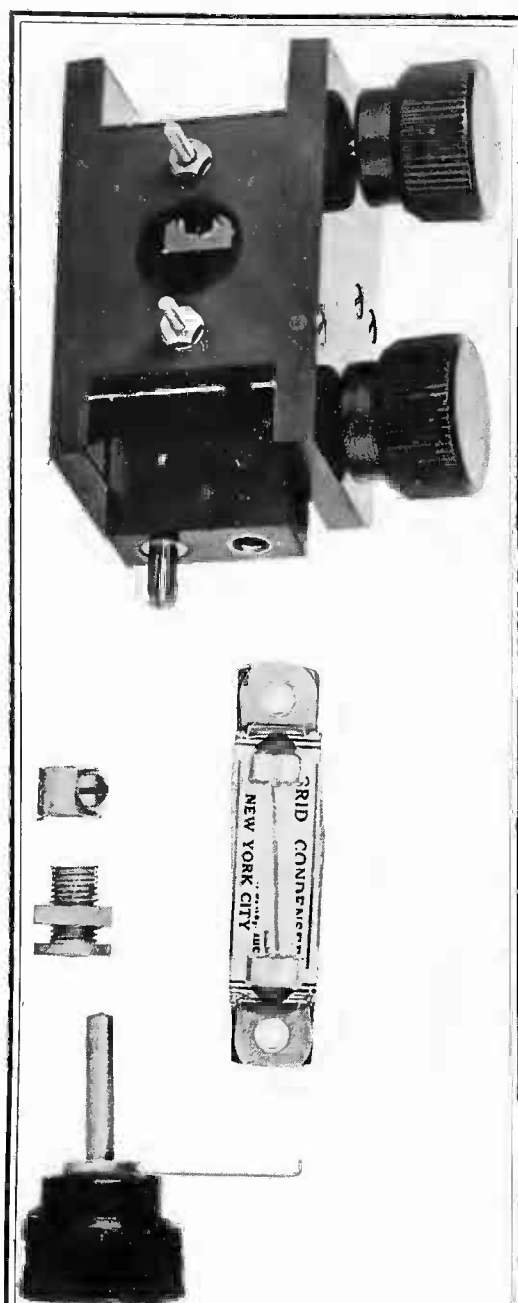

The new adjustable triple coil mounting the simplest mounting to install on your set, constructed of the highest grade insulated material.

LIST \$4.50

Switch

Nickel - plated highly polished.

LIST \$0.50

Grid Condenser

LIST \$0.25

We also are manufacturers of Receiving Sets and Parts

Reliable Radio Works

Incorporated

135 West 3rd Street
New York City



Our Radio Department is conducted by electrical engineers which assures you with dependable and highly efficient Radio equipment, either in complete sets or separate units, such as Head Receivers, Varicouplers, Variometer, Cabinets, Detectors, Antennas, Rotary Spark Gaps, Sliders, Panels, Dials, Knobs, Condensers, Grid Leaks, Contacts, Galena Crystals, etc.

For a popular home receiving set we recommend the RESODON. This set comes in a beautiful mahogany finished cabinet. Write for literature.

PAUL G. NIEHOFF & CO., Inc.

Electrical Laboratories and Manufacturers
238 E. Ohio Street Chicago



"LITTLE WIZARD" CRYSTAL DETECTOR

For Immediate Delivery

In design, workmanship, and sensitiveness, beyond a question, a vastly superior instrument. Rugged composition black enameled base, posts and trimmings of highly polished nickel, galena enclosed in a moisture-proof transparent casing which can be removed if necessary. Improves efficiency of any crystal receiving set. Its appearance, fine workmanship and extreme sensitiveness assure large, steady sales and repeats.

A New Jobbing Service for a New Business

The radio industry has peculiar problems of its own. We have devoted ourselves to creating and improving a service of supply to fit the needs of this new business.

By experience and through advantageous connections, we are able to serve dealers in a way that means better business for them.

Let Us Quote on Quantities of Items in Our Line

For Immediate Delivery

JACKS	ALL PARTS
No. 30 Single Circuit Open	Binding Posts (un-removable head)
No. 32 Double Circuit Close	Fixed Condensers
No. 31 3 Spring Automatic Filament Control	Switch Lever
No. 33 5 Spring Automatic Filament Control	Duplex Adapter
	Complete Crystal Sets
	Double Slider Tuning Coils
	Coils
	Lightning Switches
	Vacuum Arresters

Agents for Brandes
"Superior Type Matched Tone"
Headsets

NORTH WARD RADIO CO.

72 Orange Street
NEWARK NEW JERSEY

SAYS RADIO REALLY CURES CANCER

Some forms of cancer, considered incurable for years, have at last surrendered to science, according to Dr. T. Howard Plank of Chicago. Its external manifestations can be cured by radio, he asserts.

Before the National Society of Physical Therapeutics, at the annual convention of the American Institute of Homeopathy, held at Chicago June 19, Dr. Plank promised to demonstrate his contention at a clinic. Two sufferers from cancer have already been healed, he maintained, the last not two weeks ago.

"The electric scalpel is run by radio," he explained. "The machine uses the same current that is used in sending radio messages. The treatment is an absolute and permanent cure for cancer where it can be reached on the surface."

"There is no actual contact between the diseased tissues and the knife," Dr. Plank went on. "As soon as the instrument approaches the flesh the infected part withers up and disappears."

The patient is placed under twilight sleep, the surgeon said. In four or five days he is out of bed and in ten or twelve days is on the street again.

THE VOX HUMANA

The manufacture of radio sets is now settling down to the production of neat instruments and even beautiful appliances. To the latter classification belongs the artistic "Vox Humana" produced by the Radio Guild, Inc., New York.

The Vox Humana is a receiver built like a high-priced phonograph, and like a phonograph the reproduction of human voices and sounds is very lifelike. The feature of the instrument may be said to be the purity of its reproductions, which are unusual for the absence of extraneous noises or interference when the instrument is required to "re-create" loud, clear and undistorted noises. Indeed, with regard to the playing of piano music, the Vox Humana is said to be far clearer and purer than radio's forerunner, the talking machine.

The instrument is designed for use in the home and public places for the receiving of broadcasting programmes. There are two models. Model A is designed for home use and Model B, with its greater amplification, is suited especially for hotels, restaurants and auditoriums. Everything for the operation of radio is within the cabinet. There are no wires visible. The makers claim that the Vox Humana will receive radio concerts with a loop about 100 miles.

Maclite Vario-Coupler

Price \$5.00

Is, in the opinion of experts, the most efficient on the market.

All Other Maclite Parts are equally efficient, including the Maclite Variometer, Double Slide Tuner, Variable Condensers and Crystal Detectors. The Maclite Single Tube set at \$25.00 is the best buy we have ever seen. Let us tell you more about this set, also all other Maclite parts.

Dealers and Jobbers Write for Discounts

MACLITE RADIO CO.
701 Maclite Bldg., Claredon St.
Boston, Mass.

"AERIALITE"



The Lamp Socket Aerial

Get your orders in now for "Aerialite" Instruments. Safe, sane, dependable! Simply insert in lamp socket and receive the broadcasted music. No cumbersome antennae or ground wires. The "Aerialite" is a perfect instrument in all details and is guaranteed to give perfect satisfaction. For V. T. sets, and in cities where there are broadcasting stations it may be used with satisfactory results on crystal sets.

Lists at \$2.00

Attractive Proposition to Dealers

Manufactured by

The Condenser Specialty Co.

23 Marshall Street
Newark, N. J.

Radio Securities

By FRANK T. STANTON

Radio shares, the last few weeks, have been very quiet. With the drop of fan enthusiasm the shares have eased off.

This was to be expected and the prices should continue to sag during the hot months.

RADIO CORPORATION

The Radio Corporation of America announces the opening of a district office of its sales department at 10 South La Salle St., and a warehouse at Unit "B" Central Manufacturing District, Chicago.

The Radio Corporation of America just issued a catalogue, which is expected to give fresh impetus to the company's business, and the company is sending a letter to radio equipment jobbers, saying in part, "This book will be a powerful sales instrument. It will be timely argument for the RCA line in your sales contract with the dealer, not forgetting the tie-up of general RCA advertising that is to follow.

"It is our purpose to stand side by side with the distributor and the dealer in their sales efforts. To this end the new catalogue will be the opening gun in a campaign which will establish the genuine worth of RCA apparatus and the integrity of the company behind it."

The company also has plans to erect broadcasting Stations in New York, Washington, D. C., and San Francisco, California.

DE FOREST RADIO

With added facilities at their new plant in Jersey City, and with the assistance of the Reynolds Spring Company of Jackson, Michigan, which company's Radio production is immense, this company is meeting its orders in a very prompt manner. They are carrying on an extensive advertising campaign for new business, and in every way have enlarged their scope. It is only a matter of time when this company will list their shares for trading on one of the important stock exchanges. Their good name and record should make the marketing of these shares a big success.

CANADIAN MARCONI

Signor Marconi, who is here on a visit, will stop off at Canada on his return to Europe. It is expected that he will carry on some of his experiments from the Canadian Marconi Company's large stations while he is there. This Company is a subsidiary of the English Marconi Co., of which Mr. Marconi is the Chairman of the Board of Directors, and is also the Vice-President of the Canadian Marconi Company. Canada has been slow in taking advantage of Broadcasting, but is now getting well under way, and has several stations sending good programs daily. London has been a big buyer of this company's shares the past few weeks. One of the reasons that comes from there is that the Radio Corporation of America is negotiating to buy control of this company.

NEW SHARE ISSUE BY AMALGAMATED WIRELESS CO.

In pursuance of their agreement with the Federal Government, in connection with the establishment of direct wireless communication between Great Britain and the Com-

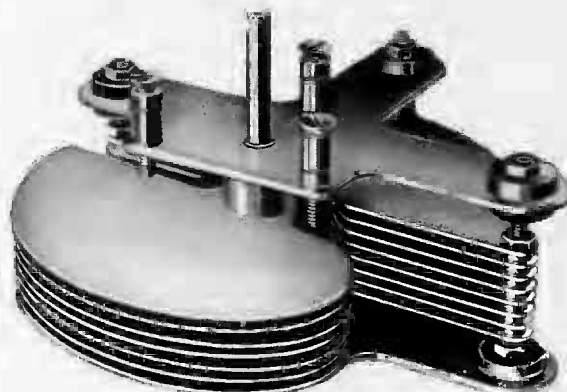

A Variable Condenser
Rigidly Inspected

of hard Aluminum plates adds to the sensitivity of a receiving set. Special movable plates afford delicate adjustment on starting engagement. Proper rate of capacity increase is assured throughout the range. Lock nut and double end bearing of dial spindle maintain positive adjustment of movable plates and prevent short circuiting. Heavy gage metal end-plates afford superiority over material that warps.

List Price, .0005... \$3.75
.001... 4.75

Crystal Detector
Rigidly Inspected

A crystal detector with a universal adjustment permitting the whole face of the crystal to be searched for sensitive spots. Will maintain a constant pressure on crystal and cannot be jarred out of adjustment after setting. One piece crystal holder will take either unmounted or mounted crystals.

List Price, 75c

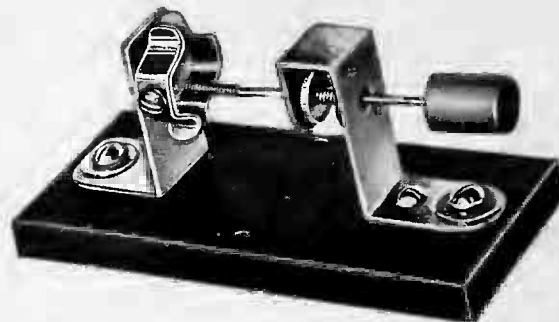

Distributors and Dealers Write for Our Propositions

DIAMANT TOOL & MFG. CO., INC.

93 Runyon St., Newark, N. J.

Ask Our Service Bureau

The Mystery of Sound

ALL resonant musical instruments give forth rich and mellow tones because they have resonant sound chambers. Human speech is vibrant because it is resonant through a series of graduated sound chambers and released through a perfect projector—the

Richtone LOUD SPEAKER

employs these principles. The sound impulse is taken from the head telephones and transmitted into a perfected sound chamber, the form and design of which is patented. Full sound wave

energy is then obtained by setting in vibration a series of ten graduated chambers, the shape, proportion and size of which required months of research to determine.

The sound is released through a projector, the curve of which is patented. There is no wave interference; sound from the Richtone is transmitted directly to your ear.

Made of heavy brass tubing—not rolled tin. Disassembles into four parts making a small neat package. List Price, Twelve Dollars.

Variable Condensers—V. C. 4, 5 and 6. 17, 23 and 43 plate International Variables. Heavy brass posts, machine assembled. This is *not* a washer type of variable.

List Price..\$4.00, \$4.25 and \$4.50

INTERNATIONAL RADIO CORPORATION

42 BRANTFORD PLACE, NEWARK, N. J.

monwealth, the directors of Amalgamated Wireless (Australasia), Ltd., are taking steps to have the company's articles of association altered to provide, inter alia, that the authorized capital shall be increased to £1,000,000 in £1 shares, and that 301,500 new shares shall be offered to shareholders for subscription at par, in the proportion of five for every three existing shares held on May 10th next, payable: 1/ per share on application, 1/ per share on allotment, and the balance in calls of such amounts and at such time as the directors may from time to time determine. The application list is to close on May 31.

REYNOLDS SPRING

A party of Wall Street men interested in Reynolds Spring have just returned from a visit to the plant at Jackson, Michigan. They declare themselves as most favorably impressed by what they found. Efficiency, they state, is everywhere. The entire spring works have been moved into the new plant, situated about a mile from the company's other building. This building has been turned over exclusively to the manufacture of radio equipment, which the company handles under its contract with De Forest. Orders are coming in steadily, and while income has shown a satisfactory increase recently, it is stated that July and August are likely to establish a new high record.—*N. Y. American.*

The directors of the Reynolds Spring Company, in addition to declaring the usual quarterly dividend of 1 3/4% on the Company's preferred "A" stock, has also authorized the payment of two years' accumulated dividends on the preferred "B" stock.

ENGLISH MARCONI

Regarding English Marconi, "Stanton's Wireless Bulletin" for June published the following message from their London correspondent.

STANRAY, New York.—The English Government has offered the English Marconi company £800,000 sterling to settle their war claims, but the Company has refused to accept that amount, and asked £1,500,000 sterling. As both parties could not agree on the amount, they have decided to form a commission, the English Government and the English Marconi Company to have the same amount of representatives to sit on the commission to decide, and they start to meet the first week in June, and keep on having meetings each week until settled.—STANRAYMUR.

The above indicates that the English Government is willing to pay approximately \$3,500,000, but the Company wants about \$6,700,000. The opinion in London is that they will compromise on the sum of \$5,000,000. A settlement on this basis would mean an additional value to the stock of about \$1.60 per share.

STOCKS	Bid	Ask
Amer. Marconi Stamped.....	5c	20c
*Amer. Tel. & Tel.....	119 7/8	120
Canadian Marconi	2 1/4	3 1/4
Cuban Tel. Co. common.....	65	85
Cuban Tel. Co. preferred...	80	90
De Forest Tel. & Tel.....	5	10
Dubilier Con. & Radio.....	8	8 1/4
English Marconi common ...	10	14
English Marconi preferred ..	10	14
Federal Tel. & Tel. of Cal..	6	6 1/2
*General Elec. Company	164 5/8	166 3/4
International Tel. & Tel.....	50	65
Marconi Int. Marine	7 1/2	8
Radio common	4 1/2	4 5/8
Radio preferred	3 3/8	3 1/2
*Reynolds Spring	47 1/2	48 1/2
Spanish Marconi	1	3
*United Fruit	137	138

Radio to Have Same Destiny As Other Great Inventions

By ALEXANDER CLEMENTS

President American Radio & Electric Co.

When Morse invented the electric telegraph and announced the success of his experiment in sending a message by wire from Washington to Baltimore, how few there were who realized the importance of this demonstration.

Bell, the inventor of the telephone, met with a rather discouraging reception when trying to introduce his telephone.

Edison with his arc light experienced similar difficulty in proving the importance of his new lighting system.

The original talking machine aroused a mere curious and passing interest in the first demonstration.

The moving pictures at first excited a mere transient interest which showed signs of public indifference during its early development.

All of the industries and enterprises enumerated in their primitive forms were thought to be commercially impracticable and mere crazes and hob-

bies, so that one can easily understand why the present wireless interest is considered by people of no vision a mere passing craze.

Much worthless wireless apparatus has been sold which was imperfectly and unscientifically constructed and which naturally has discouraged innumerable beginners in this new science.

But I believe now that the radio industry will take on a new impetus with the improved and scientifically tested radio mechanism and will prove one of the greatest boons in furnishing information, education and entertainment to every home in every hamlet, village and town.

Judging from the orders and inquiries we are now receiving we anticipate a tremendous demand this fall as every indication shows a marvelous revival of interest in radio and the manufacturers should adopt some plan of standardization to insure the public of approved appliances.

LATEST and MOST POPULAR

Radio Books

- Radio Hook-Ups**, by M. B. Sleeper..... \$.75
An indispensable book to the radio amateur who designs or builds his own receiving apparatus.
- Radio Design Data**, by M. B. Sleeper..... .75
A book giving tables and data for designing receiving and transmitting apparatus.
- Construction of New Type Trans-Atlantic Receiving Set**, by M. B. Sleeper .75
Tells how to listen to the high-power telegraph stations of foreign countries.
- Construction of Radiophone and Telegraph Receivers for Beginners**, by M. B. Sleeper..... .75
Tells in detail the building of radio apparatus.
- How to Make Commercial Type Radio Apparatus**, by M. B. Sleeper.. .75
Describes in detail many commercial types of transmitting spark and vacuum tube sets, both telephone and telegraph and receiving equipment of all kinds.
- Wireless Telegraphy and Telephony Simply Explained**, by A. P. Morgan..... 1.50
A book the Radio experimenter cannot afford to be without.
- Experimental Wireless Stations**, by P. E. Edelman..... 3.00
A book describing all modern improvements.
- A B C of Vacuum Tubes Used in Radio Reception**, by E. H. Lewis. ... 1.00
A book explaining in detail all about vacuum tubes.

FREE! Catalogue of Wireless, Automobile and Other Books Sent Free on Request

The Norman W. Henley Publishing Co.

2 West 45th Street, New York

Liberal Discount to Supply Houses. Write for full particulars and dealer's proposition.

Du Kane
Variable Condensers
All Metal
High Capacity

43 }
23 } Plate Sizes
17 }
11 }

Immediate Shipment
Any Quantity

Duquesne Radio & Mfg. Co.
6426-28-30 Hamilton Ave.
PITTSBURGH, PA.

SELLS AT SIGHT
VARIO COUPLER KNOCK-DOWN
Complete Parts
BOXED

Tube—Black Insulated. Rotor—Hard wood.
Hardware—Brass—NICKEL
PLATED, including Hard
wood Base for mounting.

List \$1.50
Liberal
Discount

THE R. C. MILLS
Manufacturers Agents
30 East 23d Street New York City
Sales Representatives Wanted.

PRESCO
Sectional **UNIVERSAL**
Radio Outfits

Licensed under Armstrong
U. S. Patent No. 1,113,149

Set of Three Units:

Tuner and Detector Unit... \$ 50.00
Two-Step Amplifier Unit... 35.00
Unit for holding "A" Battery
Top and Bottom, which when
added to the three other
units, make a complete section
all in one. Each, \$5; both 10.00
Complete Set, Total..... \$104.50

Ask your dealer; if he cannot supply,
write us. Dealers and Jobbers: write
for discounts. Dept. 865.

PRESCO
RADIO
Davenport, Iowa, U.S.A.

Free Will help
YOU increase
sales

This catalog will show you how to secure the names of your best prospective customers. Those you want to reach most. Counts and prices are given on thousands of different lists, covering business concerns, professions and individuals, such as Noodle Manufacturers, Druggists, Coal Mines, Farmers, etc. Personalized sales letters and descriptive literature mailed to live prospects will increase your sales by creating direct orders or inquiries.

99% Guaranteed Mailing Lists backed by our 5¢ refund

Insure your getting up-to-date information, for our lists must be compiled from latest sources to avoid heavy losses through the guarantee.

Send for FREE Reference Book today
A postcard will bring this valuable sales help.
ROSS-GOULD CO., N. 10th, St. Louis.

Ross-Gould
Mailing
Lists St. Louis

Antenna Can't Cross Alleys in Chicago

By F. D. PEARNE

Chief Instructor, Dept. of Electricity, Lane Technical High School

No part of the antenna system, including the antenna, its supports or supporting structure, shall project upon or cross any public street, alley or other public property, unless installation has been authorized by the City Council of the City of Chicago in accordance with the provisions of Sections 2500 to 2503 of the Chicago Code of 1911. This is included in the new radio ordinance.

The Commissioner of Gas and Electricity or his assistants shall have the power and it shall be their duty carefully to inspect all installations. They have the right to enter any building when deemed necessary, to inspect such installations, and it shall be unlawful for any person to interfere with them in the performance of their duties.

If upon inspection it shall be found that installation is safe, the commissioner shall issue a certificate of inspection.

The use of such radio apparatus will be declared to be unlawful previous to the issuance of such certificates, provided, however, the Commissioner of Gas and Electricity may issue a temporary permit for use of apparatus during the course of construction or alterations.

The said Commissioner of Gas and Electricity is empowered to inspect and reinspect all radio sending and receiving equipment.

When such equipment is found to be unsafe to life or property he shall notify the person or persons owning, using or maintaining such equipment to place same in a safe and secure condition within forty-eight hours.

Previous to the issuance of the permit provided for in Section 2, there shall be paid, by the person or persons

making application for such permit, and collected by the city collector, inspection fees in accordance with the following classifications:

- Receiving stations only, \$3.
- Transmitting and receiving stations, \$5.
- Reinspections, \$1.50 per hour.
- No inspection for less than \$1.50.

DEALERS

Have you tried "PRACO" Service?
We are distributors to the trade for all representative manufacturers, and specialize in the cutting of panels and tubing to your order.
Have you our latest price list and discount sheet?
PITTSBURGH RADIO AND APPLIANCE CO., Inc.
Desk D
112 Diamond St., Pittsburgh, Pa.

SALES ORGANIZATION

with established reputation among radio manufacturers, jobbers and dealers in the Metropolitan District will consider promotion of one additional production exclusive basis. Can give references and prove past results.
Box E. A., RADIO DEALER.

ATTENTION MR. DEALER

Do you find any difficulties in obtaining your desired Radio supplies? If so, wire or write us your needs. We carry standard supplies that are sold with a guarantee.

A postcard will bring you our catalog.

Our Policy
Quality, Delivery, Guarantee

WHITE RADIO CO.
Distributors
141-3-5 West 33d Street
NEW YORK CITY

ROYDART DETECTOR

The makers of the "Roydart" products also make a double barreled crystal set detector. This has two galena crystals held in cups. The set also permits of satisfactory adjustment of the cat's whisker through simply pressing the two spring leaves that hold the rod. As soon as the pressure on the spring leaves is removed the rod stays "put." The "Roydart" line also includes a system of vacuum tube set units that permits of a gradual upbuilding of the set as the enthusiast becomes more and more proficient.

Within $\frac{1}{3}$ the Width of a Hair!—

*that's the accuracy test on all
Standard Variable Condensers*

SEE THESE
EXCLUSIVE
FEATURES:

1. Solid brass rod construction (not a "washer" type), machined to an accuracy of $\frac{1}{2}$ of one-thousandth of an inch over all, assuring perfect plate alignment.
2. Minimum capacity approximately $\frac{1}{3}^\circ$ of maximum, practically eliminating the necessity for a vernier.
3. Genuine Bakelite ends—large enough to protect aluminum plates.
4. Machine made from start to finish—a precision instrument. Guaranteed to fulfill the most exacting requirements of long distance receiving sets.

CAPACITIES (Approximate)	LIST PRICE
41-Plate, .001.....	\$4.00
21-Plate, .0005.....	3.50
11-Plate, .00025.....	3.00

JOBBER
and
DEALERS
ATTEN-
TION

Quality and appearance of this condenser have made it a fast seller. Write at once for prices, discounts and sample offer.

RADIO PARTS & MANUFACTURING CO., Dept. 1008—127 No. **CHICAGO**
Dearborn Street

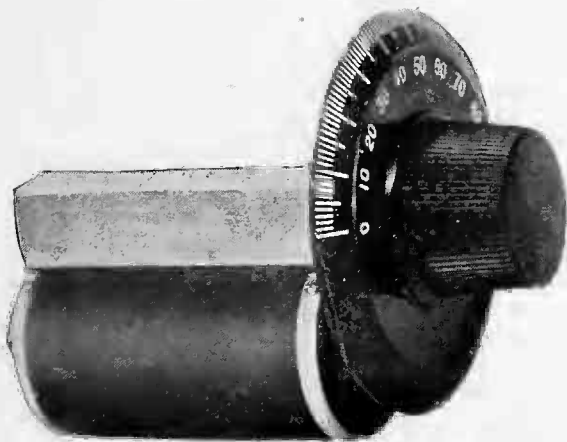

DRISCO POTENTIOMETER
Wire Wound

List\$4.00

*This booklet may be had by responsible
dealers upon application to*

HAROLD M. SCHWAB, Inc.
Radio Specialties
419 West 42nd St., New York City



HAROLD M. SCHWAB, Inc.
Sole Factory Distributer for
DRISCO MFG. CO.

Announces
a booklet descriptive of
DRISCO PRODUCTS

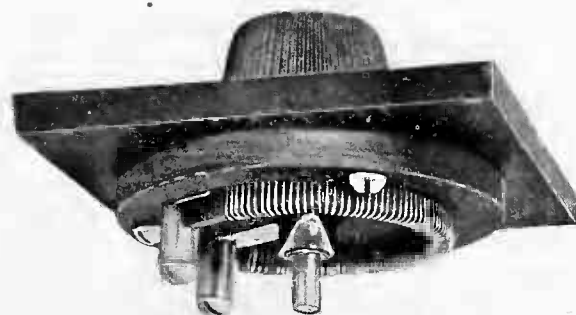

DRISCO RHEOSTAT
Type DR 4

List\$0.80

Entire line on exhibition at Booth 87, National Radio Exposition, Leiter Bldg., Chicago, June 26
July 1

Explains Broadcasting of Advertising Programs

THE RADIO DEALER,
1133 Broadway,
New York City.

Your letter asking certain questions in regard to radio broadcasting has just come to my attention and I welcome the opportunity to tell the story of broadcasting as we see it.

Coincident with the wave of popular interest in radio broadcasting which has recently swept over the country, the American Telephone & Telegraph Company and its subsidiary the Western Electric Company received a very large number of requests from various business houses for the sale, to them, of private radio broadcasting equipment. The number of requests coming from business houses in New York City alone numbered more than sixty. Taking account of the well-known limitations of the ether for the transmission of simultaneous messages it became apparent that the proper means of satisfying the demand for broadcasting facilities was not to install private broadcasting stations, as these would be so numerous in the large cities that the resulting interference would entirely preclude the obtaining of satisfactory results by the owners of any of these stations. A survey of the situation indicated that the only possible policy would involve the erection, at proper intervals, of a central broadcasting station whose facilities might be leased by any business house for such periods as it might desire to broadcast programs.

The American Telephone & Telegraph Company is erecting such a public broadcasting station and, as has already been announced, it will broadcast no programs of its own but will simply radiate those supplied by the business houses which become its patrons. It is not anticipated that any rigid censorship will be required of the programs submitted for broadcasting through this station, as the natural inference is that business houses hiring the station would submit only such programs as would attract and merit the attention of the radio listener. However, experience alone will provide the basis upon which a definite policy governing the operating of the station can be formulated. For this reason and until such a policy is forthcoming it is proposed to call the station

an "experimental public broadcasting station."

You furthermore ask the question as to whether we will broadcast advertising. Before this question can be answered some common understanding as to what constitutes advertising must be arrived at. Looked at from the broadest point of view all of the radio broadcasting which has thus far been done is nothing more than advertising. Its purpose is to either stimulate the sale of radio equipment or to focus attention on some other proposition. If the word "advertising" is interpreted in this sense it seems likely that radio broadcasting must invariably be of an advertising nature.

However, in any discussion of broadcasting advertisements it is well to bear in mind one fundamental principle. When this is done, the fear which is sometimes expressed that advertising will destroy broadcasting is seen to be without foundation. Radio advertising, like all other forms, must be of such a character as to make a favorable impression upon the public, and it is quite incredible that any business firm would jeopardize its reputation and potential market by attempting to broadcast material which experience proved would not meet with a favorable reception.

Trusting that the above comments will be of interest to you, I am

Yours very truly,
Publicity Dept.
J. H. ELLSWORTH,

RADIO IN TIMES SQUARE

On the busiest square in the world, Times Square, New York, an upstairs radio shop lets its loud speaker go every night. Large crowds gather in front of the "New York Times," which is opposite the radio store, and listen to the programmes broadcasted from Newark.

MIDWEST BROADCASTS

Chicago has another broadcasting station atop the Wrigley Building, operated by the Midwest Radio Company and known as WDAT, transmitting on a 360-meter wave length, and it is said to transmit in excellent style.

THE AMERACO CRYSTAL RECEIVER

Price \$18.00

A remarkable and capable receiving instrument, neat in appearance, made of the best materials and cheap in price. A Radio achievement. Send for pamphlet.

Mr. Dealer: Are we doing anything for you?

THE AMERICAN RADIO COMPANY OF BROOKLYN
2635 East Nineteenth St. Brooklyn, N. Y.

VOLTA

PRODUCTS

ARE OF

EXCEPTIONAL PERFECTION

Crystal Sets, \$7.50 List
Variometers, \$2.75 List

Volta Engineering Co.
1724 Lorimer Street
Brooklyn, N. Y.

PANELS

BAKELITE

DILECTO

All standard sizes in stock for immediate delivery.
Orders for special sizes received before noon shipped the same day.

Price lists with sizes and discounts upon request.

CLARK & TILSON

51 EAST 42nd STREET
NEW YORK CITY

A Trial Order Will Demonstrate Our Reliability

**MANUFACTURERS
JOBBERs—**

**Have You Seen
The Radio Dealer
WEEKLY**

?

This weekly folder issued by the Service Bureau of The Radio Dealer lists inquiries of dealers all over the United States and Canada

SEND FOR SAMPLE COPY TODAY

Service Bureau

THE RADIO DEALER

1133 Broadway

New York City.

THE MEN BEHIND "ARECO"

The new factory of the American Radio and Electric Company, which was opened at Union Hill, N. J., last month, is busily at work producing the radio equipment that the company sends out into the world as the "Areco" products.

Convinced that radio is here, and here to stay, the company is earnestly spending its energies in perfecting both its products and its organization of distribution.

Milton Stilwell, an electrical engineer of repute who has devoted many years to wireless and electrical apparatus, is in charge of the technical work at the Union Hill factory, while at the New York office, 1133 Broadway, the Siamese twins of Butler and Baldwin are in command. George G. Hyde is consulting engineer for the company. With this array of talent the American Radio and Electric Company is one of the outstanding companies in the field. Their "Areco" crystal sets, tube detectors, variometers, horns, grid leaks and amplifiers show the quality of the men behind.

HIGH GRADE CRYSTAL SET

The Regal Junior crystal receiving set manufactured by the American Specialty Mfg. Co., of Bridgeport, Conn., is the result of months of experimental work on the part of their engineering staff.

This set has been tested under all conditions and it is claimed that it will receive concerts, music and all news of the day from all broadcasting stations clearly and distinctly within a radius of 25 to 40 miles. Code messages are distinctly heard on this set over a distance of 800 to 1,000 miles. The set is designed to overcome the objections commonly attributed to crystal receiving sets, and this company, with its thirty years' experience in electrical precision work, stands back of this set with an absolute guarantee.

The set sells for \$20.00, complete with one set of Federal head phones of 2,000 ohms, and is enclosed in a mahogany finished cabinet.

CANADA TAKES UP RADIO

The charge that Canada has been slow to take up radio is no longer true. Eastern Canada is soon to be transformed into a network of 360 metre wave lengths, while in Western Canada newspapers of enterprising character are taking it upon themselves to do the broadcasting. Such a paper is the "Manitoba Free Press," which is now broadcasting as well as conducting a daily radio department in its columns.

DEALERS! JOBBERS!

We Manufacture and have in stock for immediate delivery Binding Posts, Switch Points, Switch Parts, also any other Screw Machine Products.

Crystal Detector complete and assembled without the crystal, retails at 10 cents

Good margin of profit to the dealer

ARJAY RADIO PRODUCTS

Elizabeth, N. J.

N. Y. Office, 50 Church St.

Phone Cort 4477-4478

An Authentic List of Radio Dealers in U. S.

Compiled by local investigation throughout the country; contains nearly 5000 names; up-to-date and more authoritative than any yet developed.

An Authentic List of Radio Jobbers in U. S.

Also compiled by local investigation; contains about 300 names; up-to-date and authoritative.

Investigation Report on Marketing Situation in Radio Industry

125 Typewritten pages, illustrated with graphic charts and maps; definite details and statistics on manufacturing, jobbing, retailing problems and methods. Vital, practical information for any radio concern.

High Grade Radio Broadcasting Map

Large wall map, mounted on board; marked with colored pins for stations and with circles for crystal as well as tube set radius.

These are examples of data and services available on radio from the oldest business research and service organization in the country.

The Business Bourse International, Inc.

"The National Clearing House of Business Information"

15 West 37th Street

New York City

VICTOR SETS

The Victor Electrical Testing Company, 63 East Ninth Street, are the makers of a combination phonograph and radio receiving set called the "Vecto." This radio outfit, enclosed as it is in handsome period design cabinets, uses a loop antenna inside the cabinet to do away with the necessity of an outside aerial.

The receiving apparatus of the "Vecto" is compactly built into one side of the phonograph cabinet, while the other contains the ordinary phonograph mechanism. The receiving apparatus is a three radio bulb and a two audion bulb device.

The "Vecto" products have been designed by E. Weisman, an electrical engineer of national reputation.

MAKE THREE STYLES OF HEAD SETS

A head set made in three styles is one of the features of the line put out by the General Radio Laboratories, of 7 South Dearborn street, Chicago.

Their featured head set is the Red Star of 2,000 ohms resistance. Another form of the head set is for the professional, and has a resistance of 2,400 ohms. The most powerful of the three is the Long Distance, with 3,200 ohms.

All three styles are put out with confidence by the General Radio Laboratories, who also make the Linga Condensers. Located in Chicago, the company is ready to supply the trade in the western states.

MAKE DURABLE DIAL

Featuring an "unbreakable" dial, the Astorloid Manufacturing Company, of 416 Marcy Avenue, Brooklyn, is extending the scope of its Radio line.

Their new "Amco" dial is very highly finished, having a smooth polish and very clear figures. This attractive dial has been adopted by the leading Radio manufacturers for use on the more expensive sets now on the market. The dial is not of metal, every part being of a very durable grade of composition. It is made in two sizes, the three inch selling at 70 cents, list, and three and a half inch at 90 cents, list.

A new adjustable triple coiling is also put out by the Astorloid people, which contains a patented device that locks the coil in place. This prevents the coil from being thrown out of adjustment once the station is turned in. The list price is \$5.00.

The Astorloid Company is ready to deliver their products in quantities, as their production has been organized on a large scale.



Late "Vecto" Model

USE THIS COUPON TO JOIN

THE RADIO TRADE ASSOCIATION

THE RADIO DEALER,
1133 Broadway,
New York City.

Please count us in as charter members of

THE RADIO TRADE ASSOCIATION

and send us all bulletins regarding same as they are issued.

We are jobbers . . . , retailers . . . , manufacturers . . .
of radio equipment.

Name

Town

State

Date

Saves Vacuum Tube Costs by Doubling Filaments

An announcement of interest to the trade was made recently in an interview by M. R. Goldman, of the Self-Service Phonograph Company, New York. His statement had to deal with the duplex tube, a form of vacuum tube that does away to a certain extent with some of its expense.

"The duplex tube," Mr. Goldman said, "is one of far-reaching importance, and although the duplex tube has been long on the market, only the recent tremendous expansion of Radio has made its true necessity really felt. The duplex tube was patented on April 9, 1918, and patent number 1,262,394 was granted on the basic patent for the single base, duplex filament. Other patents are pending.

"The idea behind this novel vacuum tube," he said, "is to put two filaments inside the vacuum where the ordinary vacuum tube has only one. It works the same for the detector tube or the amplifier tube. If one bulb is used to its limits, or burned out accidentally or through faulty handling, the contacts may be changed and lo! and behold! you have a new detector or amplifier."

As may be seen from the accompanying illustration his "two-in-one" vacuum tube has two filaments. All that is necessary to restore a vacuum

tube that has suffered a "blow-out" is to change the metal contact at the base of the filament from the dead filament to the remaining live one. The tube is thus ready once more for action.

Mr. Goldman asserts that this new tube has met with an enthusiastic response wherever it has been introduced. "In Monrovia, California, and in Albany, in Salt Lake City and in Dallas, this duplex tube has been a remarkable success. Its reasonable initial price and economical features are the cause," he said.

The list price of the duplex tube is \$8.50 for the detector and \$10.00 for the amplifier.

Mr. Goldman also intimated that he was at work in launching a new two-stage detector set that will be put up in period design cabinets. He expects these models to sell somewhere in the neighborhood of \$150. This enterprising member of the Radio industry is also the distributor of the Rova products, a line of radio equipment that is both complete and reasonably priced.

But Mr. Goldman's chief interest is in the duplex tube and its possibilities of making radio even more appealing to the public by making it cheaper.

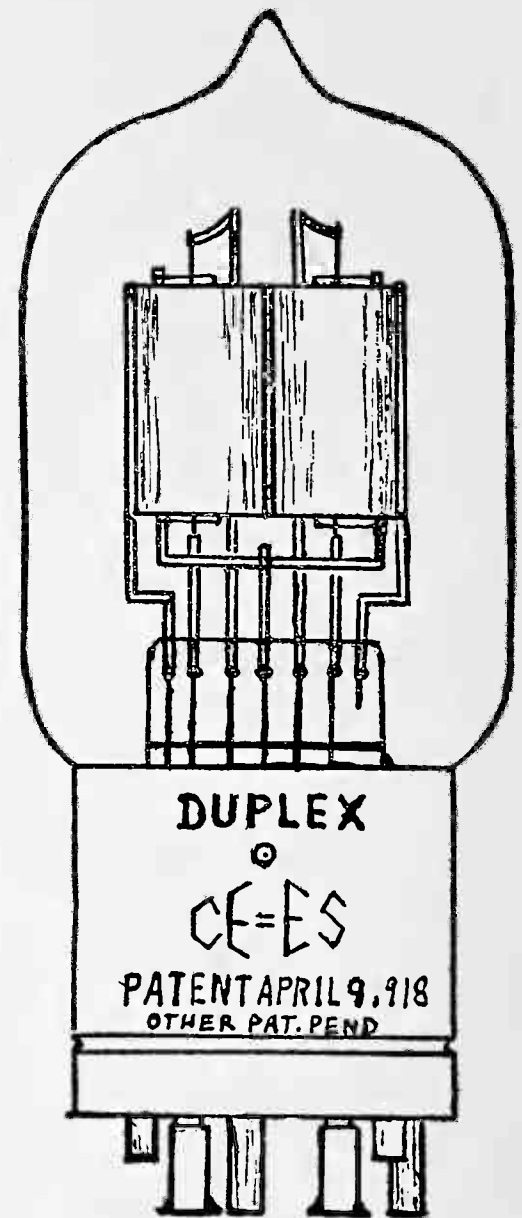

THE U. S. NAVY GOLD TIP

The 30,000 U. S. Navy gold tip vacuum tubes which were originally offered to the highest bidder, same being Jacob Levin, of New York, whose bid was \$4.04, are now being offered to the fans at \$8 each by the Merchant's Clearing House of America, 610 Broadway, New York City. They advertise "wholesale and retail."

RADIO BELLHOPS

Paging by radio has been instituted in the Essex, a Boston hotel. There is no longer a "flock" of noisy boys running through the main dining room shouting the names of various guests. Instead, the soft but distinct voice of the telephone operator is sent out to various parts of the hotel through radio devices on the telephone switchboard. Amplifiers in the lounging and dining rooms inform the guests that they are wanted.

LETONITE

A scientific composition perfectly adapted to
RADIO USE

KNOBBS
Of all
Descriptions

SOCKETS
DIALS

VARIOMETER
Rotors
and Stators

DETECTOR BASES

If it's moulded, we make it

Good
Deliveries

Quotations on
Special Work

LETONITE MFG. CO., Inc.
1265 Broadway, New York

Telephone
Pennsylvania 5633

Factory
129th St. and 3rd Ave.

BRACH vacuum LIGHTNING ARRESTER

—For many years the leader in its field and decidedly the best seller with radio equipment stores everywhere—now more in demand than ever.



The Brach Vacuum Lightning Arrester is built up to a standard, not down to a price. It is safe to sell it because it brings safety to the buyer.

Listed by the
Underwriters' Laboratories
Trade Supplied by
Leading Jobbers

L. S. BRACH MFG. CO.
NEWARK, N. J.

HENLEY'S NEWEST BOOK IS WELL PREPARED

The new edition of the Radio Experimenter's Handbook, by M. B. Sleeper, published by the Norman W. Henley Publishing Co., retails at one dollar, and tells—in a clear and concise way—the "Why" of radio.

One purpose was kept in mind by the writer in preparing this book, and that purpose was answering the practical questions of the novice as well as the more advanced student of radio.

Radio reviewing on all types of sets is clearly explained, and many helpful suggestions are given which will aid everyone. Transmitter construction is cleverly explained.

Among the contents are chapters on "Setting Up and Operating a Damped Wave Transmitter," "Apparatus Used in Simple Damped Wave Receivers," "Setting Up and Operating a Simple Damped Wave Receiver," "Radio Antennas and Grounding," "Advanced Damped Wave Receiving Apparatus," "How Does an Audion Work?" "Damped Wave Audion Receiving Set," "Advanced Damped Wave Audion Receiving Apparatus," "What Is an Undamped Wave?" "Undamped Wave Telegraph and Telephone Transmitters," "Undamped Wave Receivers," "The Audion Amplifier," "Radio Rules and Regulations."

RADIO ALPHABET

By M. J. Klein

- A—is the good old Aerial part.
- B—is the Bakelite of mountings the heart.
- C—is the Coil that tuners all have.
- D—is for Delight that Radio gave.
- E—for Electrons, Science's mystery.
- F—for the greatest "Fad" in history.
- G—for the Grid that stands all the knocks.
- H—for the Horn—the Magnavox.
- I—the Inventions that make Radio great.
- J—for the Juice that works soon and late.
- K—for the Knockers, that see only gloom.
- L—for the Lazy ones, whose middle name is "boom."
- M—for the Metre, which measures the wave.
- N—for Natural Law, Radio's slave.
- O—is Oscillation, going to and fro.
- P—for Patents, the inventor's beau.
- Q—is for Curious, and Radio is that.
- R—is for Rotor and Rheostat.
- S—is for Static, that chestnut and joke.
- T—is to Tune in, other wave lengths to choke.
- U—is Units, that all revere.
- V—the Voice, brought out clear.
- W—for Watts to measure the tone.
- X—is for X, the Great Unknown.
- Y—is for Y, spelled w-h-y.
- Z—is the Zeal to keep Radio high.

The Editor of the Retail Advertising Department of the RADIO DEALER will be glad to receive copies of advertisements that have successfully aided retailers in building up their business. Where personal criticism is desired stamped addressed envelope should be enclosed for reply.

BETTER PROFITS Selling the Jacobus Vacuum

Aerial Protector
HAS THE ADVANTAGES
EVERYBODY WANTS

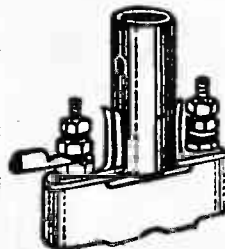

Type J.S.W.
\$2.00
List

Approved
by Underwriters to
replace the
Ground
Switch

Can Be Installed
Inside or Outside

Automatic; will not interfere with set; eliminates ground switch and lasts indefinitely—the simplest, most efficient lightning protection available.

Nationally
Advertised
Great demand created through national radio magazines and leading newspaper radio sections of the country. Get your share of the profits. Write today for discounts.

**APEX ELECTRICAL
SPECIALTY CO. Inc.**
77 Orange St. Newark, N. J.

MOUNTED CRYSTAL SET

A durable and efficient receiving set already mounted at the low price of \$7.00, list, is offered by the Detroit Radio Company, of 1 West 34th Street, New York City.

This set, which they call the "ML" type, is complete for receiving. It is mounted ready for use, and comes packed in a carton. The set consists of a crystal detector, simple and easy to operate, a condenser of .005 mfd capacity, a tested galena crystal, polished brass slider, 9 inches long, and slider contact, tuning coil, with a capacity of from 200 to 600 wavelengths, end holders, nickel binding posts and screws, and a finished hardwood base.

To go with the set, the Detroit Radio Company have designed an aerial outfit, consisting of 100 foot special antennæ wire, hard drawn bare enameled copper insulators and guy wires. The component parts of this outfit have passed the National Underwriters' Code. This is listed at \$4.00.

The company also makes Navy Type Vacuum sets, which without tube and battery, sell at a list price of \$18.00.

REAL SET FOR AMATEUR

A receiver designed for the use of the average man or boy who knows little or nothing about radio but wishes to listen in on the radio telephone concerts and broadcasts, is being offered by the Wireless Phone Corporation, of Paterson, N. J.

While this wireless set is good for the beginner, it need not be discarded when amplifiers and loud speakers are desired, the makers say.

Every Lamp Socket
an Aerial with



THE electric light wires in your home can pick up broadcasted concerts. You do not need an antenna if there is a simple way of connecting your receiving set with any electric light socket.

Substitute a Ducon for Any Electric Lamp to Hear the Music

Simply unscrew one of your lamps, substitute a Ducon, connect the Ducon with any standard receiving set—and you hear the music perfectly!



THE DUCON
\$1.50 Retail

Save the Expense of Switches and Lightning Arresters

When thus used, the Ducon does away not only with antennæ but also with switches and lightning arresters and saves all the money that they cost.

The Ducon is a perfect protective device itself and much cheaper than lightning arresters or switches. It safeguards your set.

There is no danger of shocks or short circuits. Each Ducon is tested to withstand a breakdown voltage of 3000.

Wire Your Order NOW

DISTRIBUTORS

AMERICAN ELECTRO PHONE COMPANY, Inc.

512 FIFTH AVENUE, NEW YORK

Phone Longacre 8995

Discounts to Jobbers and Dealers

LOOKING OVER NEWARK

By H. E. Bennett.

The Bender Radio Co. are now in their new quarters and are prepared to handle a large amount of business. The Messrs. Bender and Godley, of this firm, are up-to-date business men.

Eugene Scanlon, of Morcean, was at Chicago last week at the show, as was A. H. Redden, the Irvington Detector man.

Big Chief Slade, of Beaver Baby Grand fame, is well satisfied with business conditions.

J. Lehrfeld, head of the Royal Electrical Laboratories, making the Royal-phones, list \$7.50, is being complimented upon this headpiece by "men who know."

Dugdale's crystal is said to be of unusual quality, creating many satisfied customers who are using same.

The Moreland Sales Corporation are putting out a fine line of wares under the "Moradio" brand-mark.

The Kentone radio amplifying horn has become one of the standard horns. The makers, the F. C. Kent Co., are live wire folks.

The Rader Wireless Specialty Co. offer retailers and jobbers variable condensers of great merit.

"Parts for manufacturers"—as well as switches, complete sets, coils, etc., etc., are produced in good style by the Stay-Ot Mfg. Co.

Retailers around town are heard to say "business is slow." In the main the retailer is to blame, for not enough of them shout long enough and loud enough about their wares. Advertise!

L. Bamberger & Co. certainly have an up-to-date radio department. It's worth "looking at," and many dealers are "learning things" at the big Bamberger store.

The Grewol Detector is meeting with the approval of retailers, and it is a pleasure to record the fact that the makers of this detector, who also sells jacks, binding posts, etc., etc., are real business men.

The Reliable Machine Screw Co. are makers of high-grade parts. Local factories can get good results at this factory.

The Nerco is a very fine headset, made by the Newark Engineering & Tool Co., and when the boom hits the trade this fall the Nerco folks will do a lot of business.

The Klaas Cutlery Co. has a capable engineer in Brother Guild, and this factory is bound to make its name known in the radio trade, because the Klaas plant produces radio specialty parts of class. THE RADIO DEALER indorses the Klaas products and the management.

The Nelson Radio Parts Co. are getting re-orders on their Wave Unit,

Type E, listed at \$15, because it will regenerate, oscillate and detect over all wave lengths.

The International Radio Corporation feature the International Variable Condensers.

Tonk's Variable Condensers are not only properly tested but are guaranteed. That's the kind the dealers ought to sell and will sell.

The Jacobus Vacuum Aerial Protector is one of the trade's standards. Known to fan and everyone and sells promptly wherever shown.

The Echophone, produced by the General Auto Electric Co., is a fine instrument, a loud speaker of merit and has withstood every test.

The Rad'O crystal attachment is made for the crystal set, and Mr. Oliver, the owner, inventor and developer of this attachment, has had many years' experience in improving the present-day phonograph. The Rad'O makes it possible for many people to listen in on a crystal set.

Brother Turk, of the New Jersey Electrical Supply Co., is one of the live wires in the electrical field who has taken on radio selling in an intelligent manner.

John A. Cozzone & Co. make a very fine and extensive line of screw parts, binding posts, switch tops, switches and also a real variable condenser. This is a reliable house.

The A. H. Corwin & Co. are doing a good business, due to their intelligent methods of conducting business, as well as to their excellent line.

The Shelton Loud Speaker, retailing at \$5, is a marvel of simplicity and perfection, and is easy to sell—when shown to radio buyers.

The Essex Mfg. Co. are making the "Essex" (sure seller) line, consisting of the Essex lightning arrestor, Essex slider. Also tuning coils, metal dials, crystal detectors, square rods, insulators, etc. The "Essex" line is well worth featuring.

The Automotive Equipment Co. certainly have a real line for real jobbers and retailers. They are manufacturers and can handle large orders. Call on them when buying.

The Diamant variable condenser has a lock nut. Delicate adjustments are possible on the Diamant. Made by the Diamant Tool & Mfg. Co.

The Wholesale Radio Equipment Co. are real people. If they were not, THE RADIO DEALER would not carry their ad. See back cover.

The Dandy Crystal Detector, sold by the Radiophone Equipment Co. at 90 cents, list, is a real wonder.

Hintze Bros. make the famous X-Ray Insulator Adapter. It's a novel arranged example of efficiency. They also feature the result-bringing 19-strand wire.

Binding Posts — Contact Points

and

VARIABLE CONDENSERS

with patented adjustable tension

JOHN A. COZZONE & CO.

61 Arlington Street

Newark, N. J.



Ask Our Service Bureau

The "R. B. S." Announces

the consummation of arrangements with several additional of America's high-grade Radio and Radio Parts Manufacturers—welcome news to every retailing member of the "R. B. S." affecting as it does the purchase price of this added merchandise to the "R. B. S." line.

RADIO RETAILERS who have not yet joined this cooperative buying organization should investigate at once.

TO MANUFACTURERS OF SETS

Manufacturers can now purchase parts through the "R. B. S." at a considerable saving.

RADIO BUYERS' SYNDICATE

145 West 45th Street

New York

Mail This Coupon To-day

Radio Buyers Syndicate,
145 W. 45th St., New York City.

Tell us more about your cooperative buying plan and how we can save a considerable amount as a member.

Retailer

Mfr. of Sets.....

Address

Where to Buy

A Handy Guide For the Convenience of Our Readers

ANTENNA LIGHT WIRE PLUGS
 American Electro Phone Co..... 90
 General Radio Mfg. Co..... 9
 Super Antenna Co..... 15
 C. Bisgard & Co..... 94
 Condensile Specialty Co..... 79

AERIAL RACONY PLUG
 Radio Company of New York..... 20

AMPLIFIERS
 F. C. Kent Co..... 60
 Shelton Radio Sales Co..... 5
 Herman H. Sohn Co..... 62
 International Radio Corp..... 80

ANTENNA WIRE
 "Electra" Lightning Rod Company 42
 Hintze Bros., Inc..... 45
 Copper Clad Steel Co..... 50

BATTERIES
 Novo Manufacturing Co..... 53
 Standard Electric Novelty Co..... 47
 French Battery & Carbon Co..... 54
 Enco Electric Novelty Co..... 68
 U. S. Storage Battery Co..... 44
 Manhattan Storage Battery Co... 64
 Comet Battery Co..... 64

BATTERY CHARGES
 Premier Emergency Corp..... 1

"BESTONE" PARTS
 Henry Hyman & Co., Inc..... 67

BAKELITE PANELS
 Standard Radio Parts Co..... 51

BRASS PARTS
 McKenna Brass and Mfg. Co..... 66

BINDING POSTS
 Arjay Products Co..... 86
 John Cozzone Co..... 91
 The H. H. Eby Mfg. Co..... 65
 Royal Eastern Elect. Supply Co... 46
 Premier Radio Mfg. Co..... 49

BOOKS
 E. J. Hendrickson Company..... 54
 Lefax, Incorporated..... 39
 Normand W. Henley Pub. Co..... 81
 James A. McCann..... 71
 John Firth Co..... 52

BOXES
 Weis Mfg. Co..... 46

CABINETS
 Kund and Eiben Mfg. Co..... 48
 The Miho Co..... 76

CONTRACT WORK
 Carlyle Johnson Machine Co..... 58
 E. P. Radio Co..... 64

CHARTS
 H. C. Wiley..... 66
 Diamond Tool & Mfg. Co..... 80
 Dubilier Condenser & Radio Corp., 76

CONDENSERS
 Seaboard Radio Corp..... 75
 Chelsea Radio Co..... 5
 European Radio Company..... 41
 General Radio Laboratories, Inc.... 35
 Bunting Stamp Co..... 42
 Haynes Radio Co., Inc..... 47
 Radio Parts Mfg. Co..... 83
 Scheib Elec. Radio Co..... 52
 Robins Electric Co..... 55

Meirowsky 73
 United Mfg. & Dist..... 72
 Tonks Mfg. Co..... 75

COUPLERS
 Capital Phonilier Co..... 98

CRYSTALS
 Dugdale Laboratories 44
 Harris Laboratory 48
 U. S. Radio Co. of Penna., Inc.... 42
 Million Point Mineral Co..... 48

CRYSTAL DETECTORS
 Randel Wireless Co..... 69
 The Klein Electric Mfg. Co..... 59
 North Ward Radio Equip. Co..... 79

CRYSTAL SETS
 P. & E. Brewer Radio Co., Inc..... 68
 Franklin Radio Mfg. Co..... 58
 Detroit Radio Co..... 14

COMPLETE LINE
 American Radio & Electric Co.... 12 13

DIALS
 American Radio Mfg. Co..... 46
 The Emeloid Co., Inc..... 70
 Etched Products Corp..Inside front cov.
 Letonite Mfg. Co., Inc..... 64
 New York Radio Dial Co..... 58

DIAL SWITCHES
 Virginia Radio Corp..... 9

DISTRIBUTORS
 Altadena Radio Laboratory..... 53
 Radio Shop of Newark..... 58
 Marvin B. Fallgatter..... 61
 Raymond De Wyngaert..... 54
 Harold M. Schwab, Inc..... 83
 Detroit Electric Company..... 42
 Radio Equipment Co..... 72
 Wholesale Radio Equipment Co....
 Back cover

Moss Radio Co..... 74
 Self Service Phonograph Co., Inc... 64
 Radio Buyers Syndicate 91
 Sayre-Level Radio Co..... 42
 City Supply Co..... 45
 Lehigh Radio Co..... 44
 Federal Radio and Electric Co.... 60
 Elco Radio Supply Co..... 74
 Radio Stores Corporation..... 94
 Pittsburg Radio Supply Co..... 77
 White Radio Co..... 82

ELECTROTYPERS
 Central Electrotyping Company.... 66

FIBRE SPOOLS
 Forney Fibre Co..... 68

GLASS
 Vineland Scientific Glass Co..... 66

GRID LEAKS
 Radiophone Equipment Co..... 62

HEAD SETS
 Robbins Electric Co..... 55
 Telephone Book Holder Corp..... 66

INFORMATION
 Service Bureau 8

INSULATION
 American Porcelain Co..... 46
 National Fibre & Insulation Co.... 7

INSULATORS
 Morscan Radio Company..... 11

JOBBER WANTED
 Ajax Radio Corp..... 74

KNOCK DOWN PANEL UNITS
 Simplex Radio Co..... 59

LIGHTNING ARRESTERS
 Electric Service Supplies Co..... 51

LOOP AERIALS
 Eagle Radio Co..... 72

LOUD SPEAKERS
 The Magnavox Co..... Front Cover

LOUD SPEAKER SETS
 General Auto Electric Company... 60

MAILING LISTS
 Ross-Gould Co..... 82
 Business Bourse 86
 Radio Handbook Pub. Co..... 52

METALS
 Strahs Aluminum Co..... 64

MICA
 Mica Insulator Co..... 38

MOTORS FOR WINDING
 Henry Paulson & Co..... 60

NAME PLATES
 Name Plate Co..... 52

ORGANIZATIONS
 American Radio Association..... 18

PANELS
 The Continental Fibre Company... 47
 American Hard Rubber Company... 43
 Clark & Tilson 84
 Braun Gear Corporation..... 59
 Standard Wireless Panel Co..... 71

PAPER TUBES
 Baehm Paper Co..... 44

PART MAKERS
 Steel Products Mfg. Co..... 62
 Reliable Machine Screw Co..... 54
 Merit Machine Mfg. Co..... 44
 Raymond Radio Corporation.....
 Inside Front Cover

PARTS
 Automotive Equipment Co..... 17

PATENTS
 Otto K. Zwingenberger..... 48
 Manufacturers Patent Co..... 46

PHONES
 P. M. Dreyfuss Co..... 61
 Globe Phone Mfg. Co..... 53
 General Radio Equipment Mfg. Co., 99
 Newark Engineering & Tool Co., 46
 Tector Phones 37

PLUGS
 The Wolbrack Co..... 6

PRECISION INSTRUMENTS
 Interstate Radio Corp..... 69

PUBLICATIONS
 Radio Dealer Weekly..... 83
 Radio Dealer, The..... 49
 Radio Telegrapher 10

RADIO CRYSTAL ATTACHMENT
 Rad'O 63

Where to Buy

A Handy Guide For the Convenience of Our Readers

RECEIVING SETS		SHEET COPPER		TRADE MARKS	
Am. Radio Co. of Brooklyn.....	84	McKenna Brass & Mfg. Co.....	66	Chauncey P. Carter.....	55
Automotive Specialties Co.....	70	SIGNS		TUNER AND DETECTOR UNITS	
E. M. Wilson & Co.....	70	Merchants' Sign Service.....	42	Montclair Radio Mfg. Corp.....	14
Mercury Radio Products Co.....		SITUATION WANTED		TUNING COILS	
Inside Back Cover		Box T.....	66	National Radio Co.....	48
Moreland Sales Corp.....	42	STOCK BROKERS		UNIT TYPE SETS	
Bagan Radio Supply Service.....	45	Frank T. Stanton & Co.....	62	Tresco Mfg. Co.....	82
Rosemark Radio Corp.....	67	SLIDERS		Jewett Mfg. Co.....	57
Peter Spilger.....	64	Niglo Associates.....	48	VACUUM TUBE SOCKETS	
Radio Co. of Boston.....	71	SPAGHETTI TUBINGS		Radio Electric Co.....	3
Wireless Phone Corp. Inside Back Cover		Mitchell Rand Mfg. Co.....	62	Ajax Radio Corp.....	74
National Radio Co.....	65	Mills Radio & Electric Co.....	58	VARIABLE CONDENSERS	
Profco Radio Mfg. Corp.....	43	Jewell Radio Co.....	72	Duquesne Radio & Mfg. Co.....	82
Steinmetz Wireless Mfg. Co.....	50	SOLDERING IRONS (ELECTRIC)		Montrose Mfg. Co.....	54
States Radio Corp.....	62	Post Electric Co.....	62	Universal Radio & Mfg. Co.....	66
Laurence Radio-Lectric Co.....	46	North Shore Radio Works.....	64	VARIO CONDENSERS	
Paul G. Neihoff Co.....	78	SOCKETS		David Rosen.....	58
L. P. Horning, Jr.....	69	The Radio Electric Co.....	3	VARIO-COUPLERS	
Interstate Radio Co.....	69	SWITCHES		Maclite Radio Co.....	79
M. P. Radio Co.....	64	Ford Mica Co., Inc.....	61	R. C. Mills.....	82
Corona Electric Corporation.....	50	TESTING LABORATORIES		VARIOMETERS AND PARTS	
P. E. Edelman.....	42	N. Y. Testing Laboratories.....	44	Scientific Dealers' Supply Co.....	50
Volta Engineering Co.....	84	THREE COIL MOUNTINGS		VARIOMETERS	
ROTARY SWITCHES		Astorloid Mfg. Co.....	38	Eastern Specialty Co.....	41
Storm-Lee Radio Apparatus Co.....	59	Reliable Radio Works.....	78	Nelson Radio Parts Co.....	42
ROTORS		TRANSFORMERS		Pilot Radio Mfg. Co.....	58
R. C. Mills.....	66	Thornton Transformer Co.....	44	Franklin Radio Mfg. Co.....	58
SCREWS		Arkenberg Agency.....	44	VEST POCKET SETS	
Cap Screw & Nut Co.....	50	P. M. Dreyfuss Co., Inc.....	65	Boldo Radio & Electric Co.....	48
SELECTOR PARTS		Atwater-Kent Mfg. Co.....	63	WINDING	
Norris Electric Specialties Co., Inc.	6			Montclair Radio Co.....	74
SELLING ORGANIZATIONS					
James R. Sheedy.....	64				

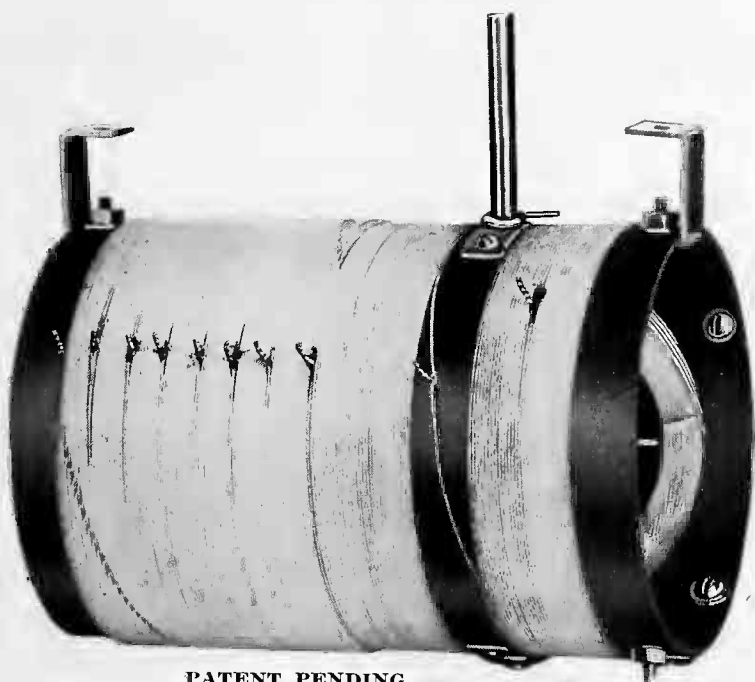

PATENT PENDING

THE NEW "ALL WAVE"

COMBINATION

FLAT AND BANK WOUND COUPLER

Guaranteed Wave Length

150 to 3000 Meters

For selective long wave and
long distance broadcast
reception

ELIMINATES

Use of all Variometers, Vario Couplers and Loading Coils. Permits of the Building of the Most Compact Receiver in Existence at a Considerably Lower Cost.

PRICE \$15.00 LIST

Distributors, wire for rights in your territory.

Manufactured by

CAPITOL PHONOLIER CORPORATION

54 TO 60 LAFAYETTE STREET, NEW YORK CITY

Shipped *NOW* by Us on
Quantity Orders!
DICTOGRAPH



**RADIO
HEAD SET**

\$12.00

Let The Radio Stores Corp.
keep you supplied to meet the
growing demand for this
popular Head Set.

We Make **IMMEDIATE SHIPMENTS!**

**222
West
34th St.
New York City**

Wire Your
Orders To-
day.

We Are Sole
Distributors of the

All Wave

COMBINATION COUPLER

See Page 93

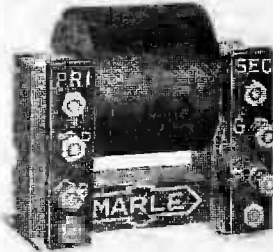

Audio
Frequency
Amplifying
Transformer

List \$3.75

Effective Frequency range, 70/3500
cycles. No distortion or howling as
usually experienced. Coil is impreg-
nated and moisture proof. Separate
terminal boards for Primary and Sec-
ondary circuits prevent current leak-
age. Used in large quantities by big-
gest reputable manufacturers of radio
apparatus, which establishes its ex-
traordinary qualifications and gives
it the best recommendation.

IMMEDIATE SHIPMENTS

RADIO STORES CORPORATION

Dept. D 222 W. 34th St., New York

"A Set is No
Better Than Its
Variable Con-
denser."

**A Step
Forward in
Variable
Condensers**

(Manufactured by Radio Stores Corporation)

Counter weight under dial. Brass studs through alumi-
num plates and die cast. Shaft held in true center
through brass bushings. Binding posts mounted on
metal straps. No insulating material tapped—metal
inserts throughout. Precision workmanship—best engi-
neering design.

- LIST**
23 Plate, \$1.25
.0005 mfd
Max. to min.
capacity ratio
12 to 1
43 Plate, \$1.75
.001 mfd

- Max. to min.
capacity ratio
22 to 1
Complete
with Knob,
Dial and
Counter
Weight. Each
packed in in-
dividual car-
ton.

**Immediate
Shipments
Maximum
Discounts**



Type VCI

Pat.
Pending

Jobbers

Attention

Dealers



"SIMPLEX" Is The Standard

(The Aerial Eliminator)

Operates with or without current; on A. C. or D. C., used for all receiving sets. Just insert the plug in the lightsocket. Reduces static to a minimum. "SIMPLEX" will not short circuit the housewiring. NO DANGER. Guaranteed to withstand 2,500 volts. Supplied with five feet of flexible cord ready for use.

"SIMPLEX" is the device the radio public has been waiting for; *the right product—the right price.*

Distributors, Jobbers and Dealers: wire, phone or write for our very liberal terms; exclusive territories granted. Immediate delivery.—List price \$1.25.—Manufactured by the Madsen & Bisgard Co.

Marketed Exclusively Through:

C. BISGARD & CO.,
Room 610, 1476 Broadway, New York, N. Y.

Phone: Bryant 10378

MERCURY RADIO PRODUCTS CO.

The Portable Set, Type M-2, shown opposite, is designed to fill vacation needs. It includes loose coupler, variable condenser, rheostat, bulb socket, grid condenser and accommodations for A and B batteries. Workmanship and efficiency guaranteed.

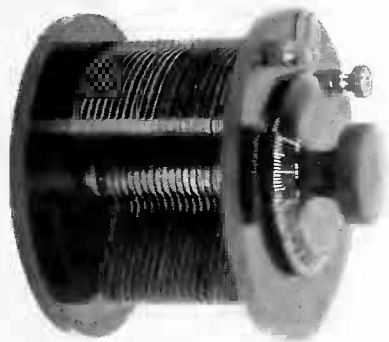

Condensers

We offer exceptional opportunities to dealers. Write for details.

Portable Set
Type M2

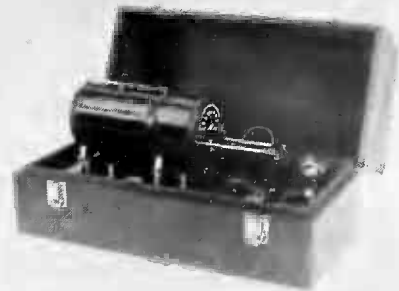

Type M3

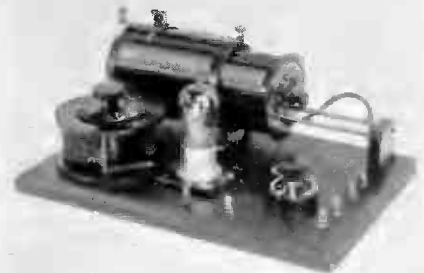

Loose Coupler

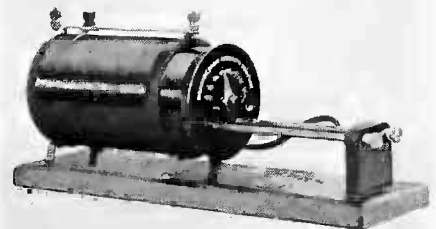

51 Thomas St. - - - Orange, N. J.

WIRELESS PHONE CORPORATION

193 ELLISON STREET - - - - PATERSON, N. J.

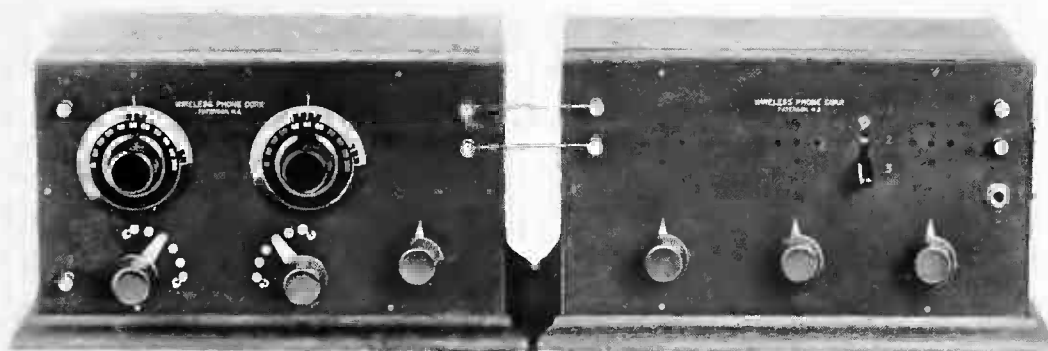

Tuner-Detector \$55.00

3 Stage Amplifier \$75.00

Non-regenerative tuner with maximum efficiency at 360 meters. Three stages of amplification without voice distortion.

Dealers and Jobbers write for proposition. Prompt Shipment.



PREPARE!

To Make Big Money

This Fall and Christmas

Radio Business is going to be larger and more profitable this fall than ever before. New developments will open up a vast potential market and sharpen the interests of all radio fans. The Christmas trade will be tremendous.

How much of this business you will get depends a good deal upon how *farsighted* you are. Remember the hectic months of the first wave of radio popularity and be ready this time with complete stocks. Don't wait till the last minute. Map out your policy, plan your operations and *place your order NOW!*

The services of the Wholesale Radio Equipment Co. will help you do the best possible business. Whatever your need, we have plenty always in stock—products of 16 or more of the most important nationally known manufacturers. Deliveries to meet every situation. Let's get together **NOW.**

Everything Comes to the Dealer Who Looks Ahead and Prepares—Profit by the Past and Order Now!

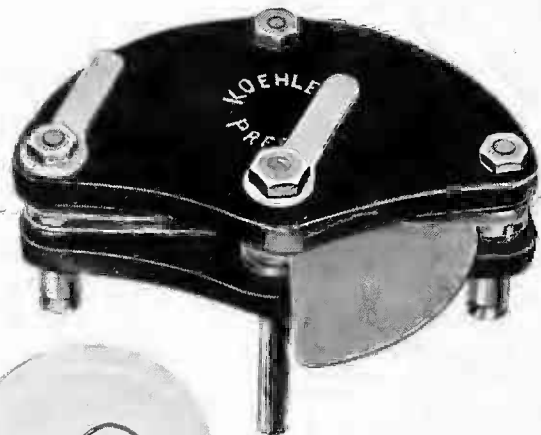

Two Very Profitable SPECIALS

Koehler 3-Plate Vernier Variable Condensers

Heavy aluminum plates, thick Bakelite ends, other parts of brass, nickel plated. .000075 MFD capacity. Other sizes. Accurately manufactured and carefully tested. Koehler Condensers have made good.

LIST

\$1.50

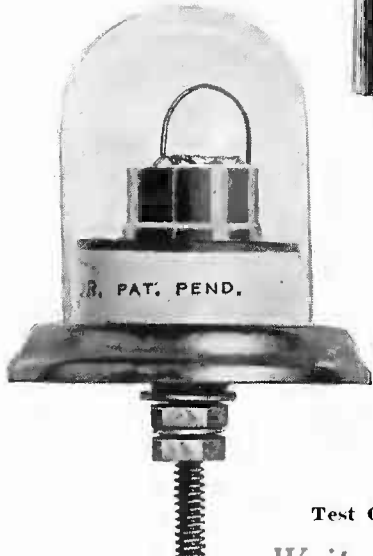

GREWOL Crystal Detectors

No trouble selling this fixed detector. Stays adjusted. Guaranteed tested crystal in dustproof glass cup.

LIST

\$2.00

Test Our Service with a Trial Order of These Two Standard Sellers

Write for Attractive Discounts on Our Complete Line

DISTRIBUTORS FOR

Ame
Baldwin
Bradleystat
Chelsea
De Forest
Eveready
Federal
Homcharger
Jefferson
Klosner
Magnavox
Murdock
Paragon
Thordarsen
Tuska
Western Electric

Wholesale Only!

Wholesale Radio Equipment Co.

24 WILLIAM STREET, NEWARK, N. J.

The Radio Dealer

Published Monthly by
The Radio Dealer Co.,
1133 Broadway, New
York, N. Y.

VOL. I No. 5

For The Radio Retailer

AUGUST, 1922

Application pending for
entry as second class
matter at the Post Office
at New York, N. Y.

ONE DOLLAR THE YEAR

STANDARD

Trade-Marked

**Nationally
Advertised**

RADIO MERCHANDISE

Will Help You Establish a Substantial Business!

Radio business will be brisk this fall and Christmas, but the radio buyers will carefully pick and choose. They will read more advertising and insist upon products of recognized merit.

The services of the Wholesale Radio Equipment Co. will be of inestimable help to you in holding this trade and firmly establishing your business. You can draw upon our never-exhausted stocks of radio products of 16 or more important nationally

known manufacturers and always depend upon delivery to the promised minute. Advantageous discounts. Drop us a line now while it is fresh in your mind. Let us help you plan your business for the next six months.



Get Your Share of the Fall and Christmas Trade NOW!
Insure Ample Stocks of Standard Parts by Ordering



**Two Very Profitable
SPECIALS**

Koehler 3-Plate Vernier Variable Condensers

Heavy aluminum plates, thick Bakelite ends, other parts of brass, nickel-plated. .000075 Mfd. capacity. Accurately manufactured and carefully tested. Koehler Condensers have made good. Also made in other sizes.

LIST

\$1.50

GREWOL Crystal Detectors

No trouble selling this fixed detector. Stays adjusted. Guaranteed tested crystal in dust-proof glass cup.

LIST

\$2.00

Test our service with a trial order of these two standard sellers

Write for Attractive Discounts on Our Complete Line

**DISTRIBUTORS
FOR**

Acme
Baldwin
Bradleystat
Chelsea
De Forest
Eveready
Federal
Homcharger
Jefferson
Kosner
Magnavox
Murdock
Paragon
Thordarsen
Tuska
Western
Electric

**WHOLESALE
ONLY**

Wholesale Radio Equipment Co.

24 WILLIAM STREET, NEWARK, N. J.

The RECENT CHICAGO SHOW:

Resulted in quantity orders from concerns ranging from Florida to California on:

THE RADIO BUILDER SET

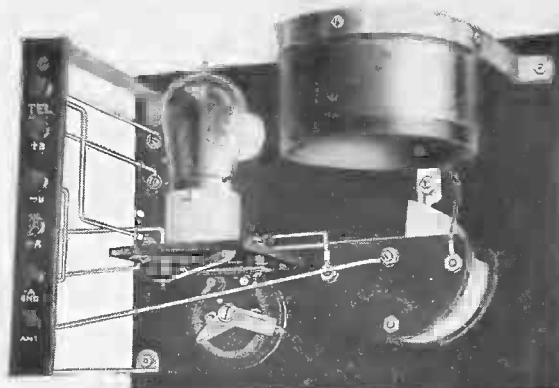
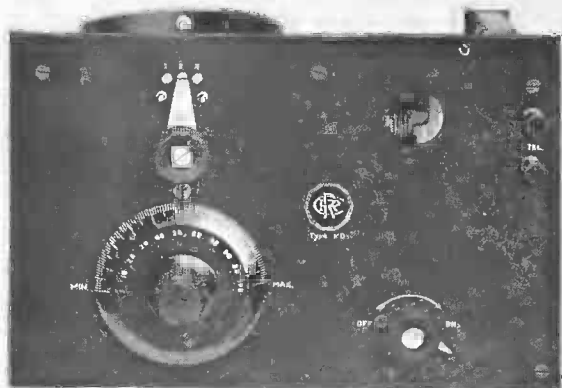

Shipped to customer in "knock-down" form and requiring only a screwdriver and a few moments to *complete* its assembly. When finished it provides a vacuum tube set which is very selective, giving extremely loud and undistorted signals. **\$30.00**

Some dealer propositions still open

The above type set is available in one, two and three tube form

RAYMOND RADIO CORPORATION

Manufacturers to the Radio Industry

Offices: 309 Lafayette Street, New York

Works: Farmingdale, L. I.

JOBBERS! DEALERS! MANUFACTURERS!

We invite your inquiries on the following:

Telephone Plugs

Fixed Condensers

Knock Down Crystal Detectors

Crystal Detectors

Eastern Distributors

"Didaic" Antenna Plug
"Aerial-a" V.T. Receiving Sets
"Grin" Variable Condensers

Write Us for Prices

THE WOLBRACK CO., Inc. (DEPT. C.)

Largest Manufacturers—Distributors of Radio Equipment

1778 Broadway, New York

"From a Contact to a Complete Set"

QUALITY

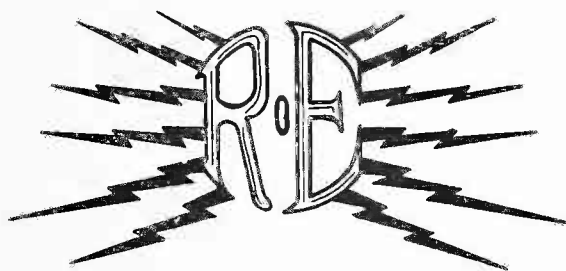

SERVICE



The VT Radiophone Receiver

175-800 Meters

THE Type AD Radiophone Concert Receiver shown in the illustration represents the most compact and modern receiving unit of its size on the radio market today. Developed primarily to meet the demands for an inexpensive but highly finished receiver, it has become extremely popular.

Its compactness and portability have won the favor of Camper and Vacationist. The ease with which it may be installed in the home and the simplicity of its operation have made it a welcome source of enjoyment in domestic circles.

The receiver consists of a single-circuit type, non-regenerative tuner in combination with a vacuum tube detector, extremely sensitive and reliable. The entire set is encased in a genuine Honduras Mahogany Cabinet, beautifully finished and measuring 5¼" x 8¼" x 5" deep. The panel is made of high grade Bakelite rubbed to a dull grain finish. It is machine engraved and the engraving is filled with permanent white. Access to the tube is provided by means of a large circular screen window shown in the top of the cabinet. This feature eliminates the necessity of having a hinged cover and affords much more protection to the interior wiring of the set. The Antenna, Ground and Phone binding posts are the only ones appearing on the front of the panel, all battery connections being made to a small panel in back of the unit.

The Type AC Amplifying Units are characterized by the same high-grade finish employed in the Type AD Receiver. They measure 5¼" x 5¼" x 5" and used in conjunction with the Type AD Receiver. One or more of these units will increase the signal strength considerably and allow the use of loud-speaking devices.

The Type AB Detector shown in the photograph has been designed for those who desire to replace their crystal detectors with the vacuum tube type. It duplicates the Type AC Amplifying Unit in finish and size and is extremely sensitive and reliable.

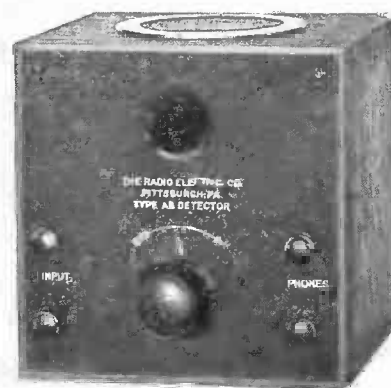

- Type AD Radiophone Concert Receiver (less tube and batteries) \$15.00
- Type AC Amplifier 14.00
- Type AB Detector 9.75

Write for Bulletin RE-3, Describing This Apparatus in Detail

SPECIAL NOTICE

WE are prepared to make measurements of resistance capacity, inductance and insulation at Radio and Audio frequencies. Audibility curves plotted. All work under supervision of experts. Prices moderate. Write for quotations.

THE RADIO ELECTRIC CO.
Manufacturers and Jobbers in

RADIO EQUIPMENT

1427-29 LIBERTY AVENUE
PITTSBURGH, PA.



HEAD TELEPHONES

NO. 52-W.....3200 OHMS
NO. 53-W.....2200 OHMS



NO. 16 V. T. SOCKET

Federal RADIO APPARATUS

The Recognized **STANDARD** of the World

HEAD TELEPHONES:
VOICE FREQUENCY AMPLIFYING TRANSFORMERS V. T. SOCKETS RHEOSTATS

And many other parts, besides
COMPLETE RECEIVING SETS

All of **Highest Efficiency**

Demand from your dealer
GENUINE FEDERAL APPARATUS
Manufactured by

Federal Telephone & Telegraph Co.

BUFFALO - - NEW YORK

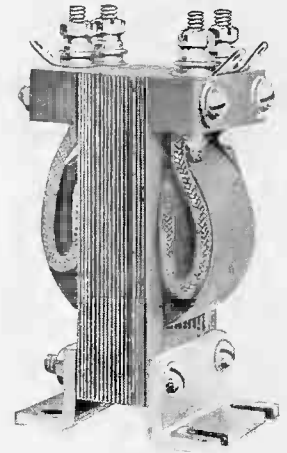

NO. 226-W
VOICE FREQUENCY AMPLIFYING TRANSFORMER



NO. 18 RHEOSTAT

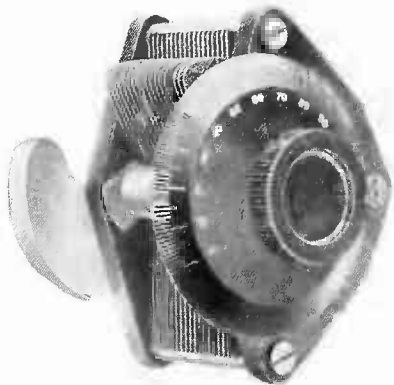

No. 3 Price \$4.75

CHELSEA

Variable Condensers
(Die-Cast Type)

No. 1.—.0011 m. f. mounted \$5.00
No. 2.—.0006 m. f. mounted 4.50
No. 3.—.0011 m. f. unmounted 4.75
No. 3.—.0011 m. f. unmounted, without dial... 4.35
No. 4.—.0006 m. f. unmounted 4.25
No. 4.—.0006 m. f. unmounted, without dial... 3.85

Top, bottom and knob are genuine bakelite, shaft of steel running in bronze bearings, adjustable tension on movable plates, large bakelite dial reading in hundredths, high capacity, amply separated and accurately spaced plates.

Unmounted types will fit any panel and are equipped with counterweight.

Guaranteed for circuits up to 1,000 volts.

Amplifying Transformer No. 50

The Chelsea Amplifying Transformer gives the highest amplification possible and at the same time will not squeal, howl, or in any way cause noisy circuits. It is beautiful in design and embodies electrical characteristics unequalled by any. Guaranteed for all circuits up to 500 volts with a high safety factor. It will not fail in service.

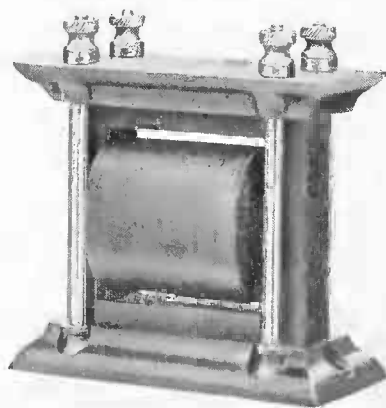

Price \$4.50

Purchase Chelsea Radio Equipment from your dealer. If he does not carry it send to us. Write for our new No. 6 Catalog



Price \$3.00

No. 21. Variable Grid Leak (Patented)

Our variable grid leak consists of ten carefully calibrated values of leak resistance ranging from 1/4 to 5 megohms.

By proper adjustment of the grid leak the potential of the grid and hence the signal strength is accurately controlled. This results in the operation of the tube at its highest efficiency and with the elimination of all squealing and tube noises.

CHELSEA RADIO CO., 150 Fifth Street, Chelsea, Mass.

Manufacturers of Radio Apparatus and Moulders of Bakelite and Condensite

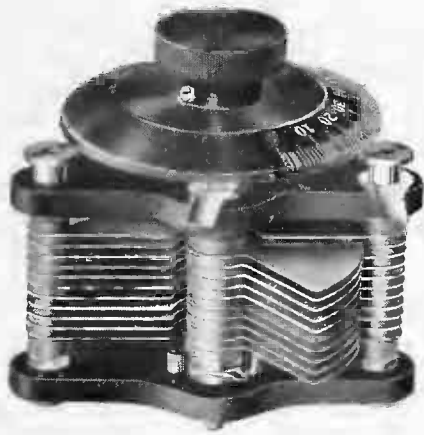

WRITE FOR
RADIO BULLETIN
No. 15

—CHELTEN—

Complete line of Jacks
Radio Plugs
Filament Rheostats
Dials and Knobs
Variable Condensers
Grid Condensers
Phone Condensers
Variable Grid Leaks
V. T. Sockets
Radio Switches
Crystal Detectors
Lightning Arresters
Antenna Receptacles

C. T. R. RADIO
PRODUCTS

Our large manufacturing
facilities combined with
Experience and Craftsmanship
enable us to offer the
BEST

CHELTEN VACUUM TUBE
PANEL UNITS

CHELTEN ELECTRIC CO.

4859-65 STENTON AVE.

PHILADELPHIA, PA.

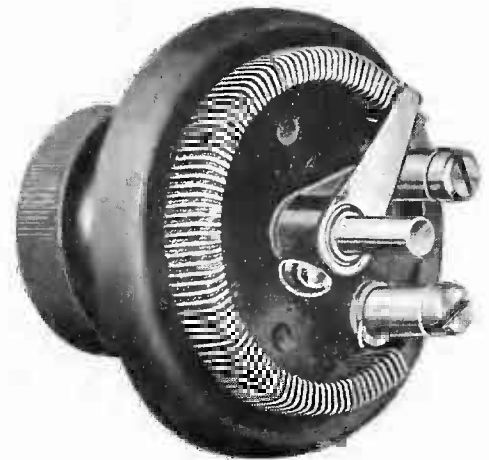

NATIONAL

SEAMLESS TUBING

in Large Diameters

For Vario-couplers, Variometers, Tuning Coils and wherever you use large diameter fibre tubing, National Seamless Tubing is less expensive and infinitely superior.

National Seamless Tubing is a specially developed, laminated tubing that retains its form and will not warp, swell or shrink. Exact in both diameters and easily worked.

Can be furnished in dark gray fibre, black fibre or dipped in insulating varnish.

Any quantities, diameters from 3" to 4 1/2" I. D. Any wall from 3/32 up.

Give us your specifications. We'll send samples and prices.

National Fibre for Panels

Hard Black Panel Stock of good dielectric strength. Gives satisfaction for condenser tops and bottoms, rheostat bases, washers, bushings, etc. Let us quote on the stock itself, or on completed parts machined to order.

Peerless Insulation

The standard thin weight fibre insulation or "fish paper."

NATIONAL FIBRE & INSULATION CO.

Box 451, YORKLYN, DELAWARE

NEW YORK
CHICAGO
PHILADELPHIA

DETROIT
SAN FRANCISCO

CLEVELAND
OMAHA

PITTSBURGH
BOSTON

ROCHESTER
BIRMINGHAM

ST. LOUIS
BALTIMORE
LONDON, ENGLAND

In CANADA, National Fibre Co. of Canada, Ltd. TORONTO



No. 47489
Simplex Vario-Coupler,
Showing Front View of
Panel Mounted Type

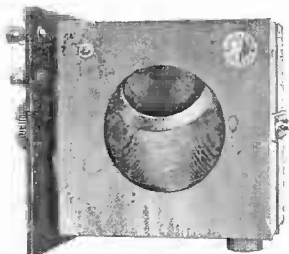

No. 47488
Simplex Variometer,
Showing Side View of
Panel Mounted Type

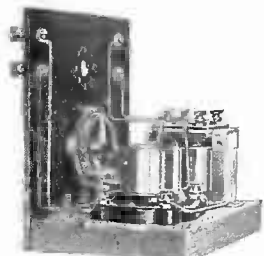

No. 47491
Amplifier Panel — Side
View

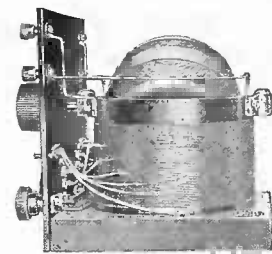

No. 47489
Simplex Vario-Coupler,
Showing Side View of
Panel Mounted Type

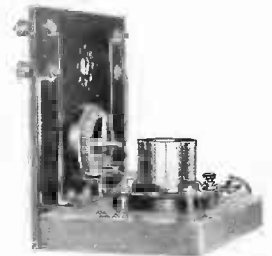

No. 47490
Simplex Detector Panel
Side View

SIMPLEX PANEL UNITS AND KEYSTONE RADIO LIGHTNING ARRESTERS

Write for Dealer Proposition

With Simplex Panel Units the user can easily change his hook-up and thus always have the benefit of the latest ideas in radio circuits. These are high-grade instruments and should be carried in every dealer's stock. Complete data and discounts on request.

Keystone Radio Lightning Arresters are approved by Underwriters; have no vacuum tube which in a short time loses and makes an arrester valueless. Weatherproof, sealed and fool-proof. Thousands and thousands in use. Write for discounts.

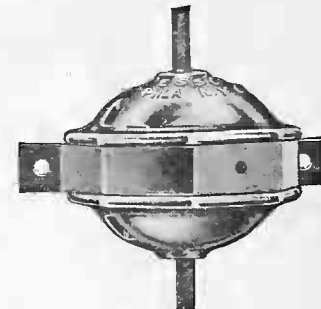

Type A, Keystone Radio Arrester. Retail Price, \$2.00

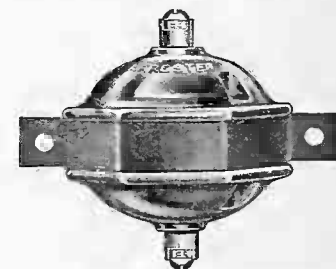

Type B, Keystone Radio Arrester. Retail Price, \$2.00

Electric Service Supplies Company

*Manufacturers of Lightning
Arresters for 30 years*

Distributors for Simplex Radio Co.

Philadelphia, 17th and Cambria Sts.; Pittsburgh, 829
Oliver Bldg.; Scranton, 316 N. Washington Ave.;
Boston, 88 Broad St.; New York, 50 Church St.;
Chicago, Monadnock Bldg.

"ARTICLES OF TRUE QUALITY ONLY— CORRECTLY PRICED"

SOLE MANUFACTURERS OF

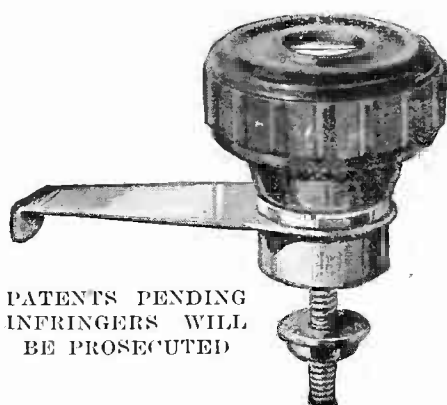

PATENTS PENDING
INFRINGEMENTS WILL
BE PROSECUTED

Fixt-Post
PATENT APPLIED FOR
Positive Contact Switch

NO BUSHINGS—NO LOCK NUTS
CANNOT LOOSEN OR BIND
NO BROKEN OR LOOSE WIRES

Every article added to the Mydar Line must first prove its worth to the entire satisfaction of our engineers—its manufacturer must prove his ability to produce not only at a fair price but also in quantities which will assure prompt deliveries.

Jobbers and retailers specializing in Mydar Products rest secure in the certainty of prompt service and of an unqualified guaranty behind every article.

We manufacture:

- ACCURATUNE—Bank Wound Couplers.
- STANZA-STRAIN—Insulators.
- FIXT-POST—Knob Switches.
- STOPSIT—Switch Stops.

We distribute:

- ACCURATUNE—Variable Condensers (Vernier, Balanced, Table and Regular Types).
- STANDARD—Model 8 Headsets.
- FCM—Insulators, Protectors etc.
- PRESTO—Antenna Superseder.
- REEL-EASY—Products.
- CROFT—Variometers and Vario-couplers.
- G-W—Products.

CATALOG NOW READY—ADDRESS DEPT. NO. 52



845 BROAD STREET, NEWARK, N. J.
WESTERN SALES DEPT.: 8405 DETROIT AVE., CLEVELAND, O.

Are You Making Money Out of Radio ?

THE RADIO TELEPHONE HANDBOOK

By H. G. Cisin, M.E.

TELLS YOU HOW

IT CONTAINS THE FOLLOWING FACTS ABOUT RADIO YOU WANT TO KNOW

What Radio Apparatus to Stock
 What Class of Radio Sets to Handle
 The Operating Principles of Radio
 The Various Types of Radiophone Receivers—the Best Methods of Adjusting Them
 How Crystal Detectors Work
 What Crystals Work Best
 How the Vacuum Tube Works
 What Is Meant by Cascade Amplification

The Principles of Regeneration
 How to Select Telephone Head Sets
 Types and Uses of Tuning Devices
 The Meanings of Everyday Radiophone Terms
 How to Select and Install the Demonstration Set
 What Service to Give in Connection with the Sale of Radiophones
 How to Utilize Newspaper and Other Publicity

With This Book You Can Tell Your Customer

The Best Way to Erect His Aerial
 Which Is Preferable, a One or a Four-Wire Aerial.
 What Determines the Length of the Aerial
 Underwriters' Requirements
 License Requirements
 How Best to Protect Against Lightning
 Why Some Radio Sets Are Simple and Others Are Complicated
 Which Sets to Recommend
 What Batteries, if Any, Are Necessary
 How High to Put the Aerial
 When an Indoor Aerial Can Be Used
 Under What Circumstances Ground Connection May Be Dispensed With
 When a Loud Speaker May Be Used
 What the Loop Aerial Is

How Amplification May Be Obtained
 Whether a Vacuum Tube May Be Used in Conjunction With a Crystal Detector
 Whether More Than One Radio Receiving Set May Be Connected to the Same Aerial
 The Correct Way to Measure Aerial Length
 When Shielding Is Necessary
 How to Check Up the Condition of the Storage Battery
 How to Eliminate Howling
 Causes and Remedies for Weak Signals and Local Noises in Connection with Vacuum Tube Sets
 How to Locate Faults in Vacuum Tube Radiophone Receiving Sets

Single Copies Price \$1.00
 One Dozen Lots 33% discount
 Four Dozen Lots 40% discount

Special Discounts on Quantity Orders

Attractive Exclusive Proposition for Distributors

Published By

THE ALLIED ENGINEERING INSTITUTE
 1400 Broadway, NEW YORK CITY

FILL THIS OUT, TEAR OFF AND MAIL

THE ALLIED ENGINEERING INSTITUTE
 NEW YORK, N. Y.

GENTLEMEN:
 SEND COPIES OF
 THE RADIO TELEPHONE
 HANDBOOK FOR WHICH
 FIND ENCLOSED \$.....
 NAME.....
 ADDRESS.....
 CITY.....
 STATE.....

Let Our Free Service Bureau Help You Supply Your Needs

Tell us your needs and we'll put you in touch with reputable firms to the end that you will receive information on the latest and best equipment. A post card will do or use the coupon below.

- | | | | | |
|---|---|---|---|--|
| <p>A</p> <p>1 "A" Batteries
2 Aerials
3 Aerial wire
4 Aerial protectors
5 Aerial switches
6 Aerial insulators
7 Aerials, loop
8 Air condensers
9 Adapters
10 Amplifiers
11 Amplifying units
12 Aluminum wire
13 Ammeters
14 Amplifying tubes
15 Amplifying horns
16 Amplifying transformers
17 Antennae, cage
20 Antenna light wire plugs
18 Audio frequency transformers
19 Automatic transmitters</p> <p>B</p> <p>21 "B" Batteries
22 Batteries, "A"
23 Batteries, dry
24 Batteries, storage
25 Battery chemicals
26 Battery chargers
27 Battery testing instruments
28 Battery switches
29 Battery rheostats
30 Battery clips
31 Battery handles
32 Battery potentiometers
33 Binding posts
34 Books
39 Boxes
35 Brass parts
36 Bushings
37 Bulbs
38 Buzzers</p> <p>C</p> <p>41 Cabinets
42 Cam switches
43 Carbon potentiometers
44 Change-over switches
45 Charging rectifiers
46 Choke coils
47 Cat whiskers
48 Cap nuts
49 Carbon walls
50 Cardboard tubes
78 Charts
51 Chopper, rotary
52 Clamps
53 Clips
54 Coils
55 Coil mountings
56 Coil plugs
57 Coils, spark
58 Condensers
59 Condensers, fixed
60 Condensers, variable
61 Condensers, air</p> | <p>62 Condensers, mica
63 Condensers, loading
64 Connection blocks
77 Contract work
65 Control panels
66 Condenser parts
67 Copper wire
68 Cords
69 Cord tips
70 Crystals
71 Crystal detector units
72 Crystal receiving sets
73 C. W. Transmitter sets
74 C. W. Filament heated transformers
75 C. W. Inductances
76 C. W. Power transformers</p> <p>D</p> <p>81 Detectors
82 Detector panels
83 Detector tubes
84 Detector minerals
85 Detector units
86 Dictionary, Radio
87 Dials
80 Dial switches
88 Dry batteries
89 Drawings
90 Diagrams</p> <p>E</p> <p>91 End mountings (tubes)
92 Engraving
93 Electrotypes</p> <p>F</p> <p>95 Fibre spools
96 Fan switches
97 Filter reactors
98 Fixed condensers
99 Fire extinguishers
100 Filament rheostat
101 Filter coils
102 Flashlights
103 Fuse terminals</p> <p>G</p> <p>106 Gaps, Spark
107 Generators
105 Glass
108 Grid condensers
109 Grid leaks
110 Grid leaks, variable
111 Grid coils
112 Ground clamps
113 Ground wires
114 Ground switches</p> <p>H</p> <p>116 Headsets and bands
117 Honeycomb coils
118 Honeycomb mountings
119 Honeycomb plugs
120 Hook switches
121 Horns
122 Hydrometers</p> | <p>I</p> <p>126 Indicators
127 Inductances, C. W. Transmitting
128 Insulators
129 Insulation
130 Invention developments</p> <p>J</p> <p>131 Jacks</p> <p>K</p> <p>132 Knock down units</p> <p>L</p> <p>136 Lead-in wire
137 Lead-in switches
138 Lead-in bushings
139 Lead-in insulators
140 Levers, Switch
141 Lightning arrestors
142 Lightning switches
143 Loading coils
144 Loading inductance
145 Loose couplers
146 Loud speakers
147 Locked lever switches
148 Lock nuts
149 Loop aerials
150 Lugs</p> <p>M</p> <p>151 Mailing lists
151 Metals
151 Magnetic modulator
152 Modulation transformers
153 Machine screws
154 Magnet wire
155 Magazines, Radio
156 Mica
157 Mica diaphragms
158 Mica condensers
159 Mica diaphragm transformers
160 Microphone transformers
161 Milliammeters
162 Milli-voltmeters
163 Motors
164 Motor generators
165 Mounting coils
166 Minerals
167 Mountings</p> <p>N</p> <p>171 Name plates
172 Nickel parts
173 Nuts</p> <p>O</p> <p>176 One stage amplifier units
177 Oscillation transformers</p> <p>P</p> <p>178 Panels
179 Panel plugs
180 Panel controls
181 Paper tubes
311 Patent registration</p> | <p>182 Patent wire
183 Patent wire terminals
184 Plans
185 Phonograph attachments
186 Plate condensers
187 Porcelain
188 Porcelain cleats
189 Porcelain insulators
190 Porcelain mountings
191 Porcelain tubes
192 Porcelain V. T. receptacles
193 Porcelain V. T. sockets
194 Precision instruments
195 Polarity indicators
196 Plate connectors
197 Paste solder
198 Phosphor-bronze wire sheets</p> <p>Q</p> <p>307 Quenching spark gaps</p> <p>R</p> <p>308 Radio books
309 Radio schools
310 Radio publications
199 Radio frequency transformers
200 Reactor, plate circuit
201 Reactor, filter
202 Receiving sets
203 Receiving head sets
204 Receiving transformers
205 Receptors
206 Receiver magnets
207 Rectifiers
208 Rectifying tubes
209 Regenerative sets
210 Rheostats
211 Rheostat wire
212 Rods
213 Rotary lever switches
214 Rotary spark gaps
215 Rotary variable condensers
216 Rubber parts
217 Rotors</p> <p>S</p> <p>221 Safety switches
222 Safety fuses
223 Sliders and rods
224 Sockets
225 Soft metal
226 Shielded dials
227 Short wave sets
228 Solder
229 Solder, bar
312 Soldering irons (electric)</p> <p>230 Spark transformers
231 Spark coil selectors
232 Spaghetti tubing
233 Special apparatus
234 Spark gaps
235 Spring clips
236 Storage batteries
237 Sectional receiving sets</p> | <p>238 Switches
239 Switch levers
240 Switch points
241 Symbols</p> <p>T</p> <p>246 Tapes
247 Telephone cord
248 Telephone plugs
249 Telephone receivers
250 Telegraph keys
251 Telegraph teachers
252 Testing instruments
253 Testing clips
254 Terminals
255 Thermometers
256 Tools
257 Trade marks
258 Transformers
259 Transmitters
260 Transmitting sets
261 Towers
262 Three coil mounting
263 Tin foil
264 Tuning coils
265 Tubes, amplifier
266 Tubes, detector
267 Tuning, flexible
268 Tube sockets
269 Tubes
270 Tuner and detector cabinets
271 Two stage cabinets
272 Two stage amplifier unit</p> <p>U</p> <p>276 Unit type receiving sets
277 Unassembled sets</p> <p>V</p> <p>281 Vacuum tubes
282 Vacuum tube sockets
283 Variable condensers
284 Variometers
285 Vario couplers
286 Variable grid leak
287 Vernier adjusters
288 Vibrators
289 Vocaloids
290 Voltmeters
291 Vulcanized fibre sheets
292 V. T. receiving sets
293 Variogrid leak
294 V. T. detector units
295 V. T. control units
296 V. T. receptacle</p> <p>W</p> <p>297 Washers
298 Watch case receivers
299 Wattmeters
300 Wave meters
301 Wave tuner
302 Wire
303 Wire, aerial
304 Wire phosphor bronze
305 Wire, copper clad
306 Wire, magnet</p> |
|---|---|---|---|--|

Note the number of the item you want to buy—then check the corresponding number in the coupon below and mail to us.

TEAR OFF HERE

1	2	3	4	5	6	7	8	9	10	11	12	13	14	15	16	17	18	19	20	21
22	23	24	25	26	27	28	29	30	31	32	33	34	35	36	37	38	39	40	41	42
43	44	45	46	47	48	49	50	51	52	53	54	55	56	57	58	59	60	61	62	63
64	65	66	67	68	69	70	71	72	73	74	75	76	77	78	79	80	81	82	83	84
85	86	87	88	89	90	91	92	93	94	95	96	97	98	99	100	101	102	103	104	105
106	107	108	109	110	111	112	113	114	115	116	117	118	119	120	121	122	123	124	125	126
127	128	129	130	131	132	133	134	135	136	137	138	139	140	141	142	143	144	145	146	147
148	149	150	151	152	153	154	155	156	157	158	159	160	161	162	163	164	165	166	167	168
169	170	171	172	173	174	175	176	177	178	179	180	181	182	183	184	185	186	187	188	189
190	191	192	193	194	195	196	197	198	199	200	201	202	203	204	205	206	207	208	209	210
211	212	213	214	215	216	217	218	219	220	221	222	223	224	225	226	227	228	229	230	231
232	233	234	235	236	237	238	239	240	241	242	243	244	245	246	247	248	249	250	251	252
253	254	255	256	257	258	259	260	261	262	263	264	265	266	267	268	269	270	271	272	273
274	275	276	277	278	279	280	281	282	283	284	285	286	287	288	289	290	291	292	293	294
295	296	297	298	299	300	301	302	303	304	305	306	307	308	309	310	311	312	313	314	315

Service Bureau The Radio Dealer,
1133 Broadway, New York City.

We are interested in buying radio equipment and have circled the numbers on this coupon of the items we are ready to buy now. Please have manufacturers of these lines quote us dealers' prices.

Name

Address

We are
—Retailers
—Jobbers
—Manufacturers

1922

The New Armstrong Super Regenerative Receiver

How to Construct and Operate It With Twelve Photos and Diagrams of Sets Actually Constructed by the Author. The Only Authentic Book

By **KENNETH HARKNESS**

Price, 50 Cents

At your Dealer or direct from the Publishers

256 West 34th STREET

The Radio Guild, Inc.

NEW YORK CITY

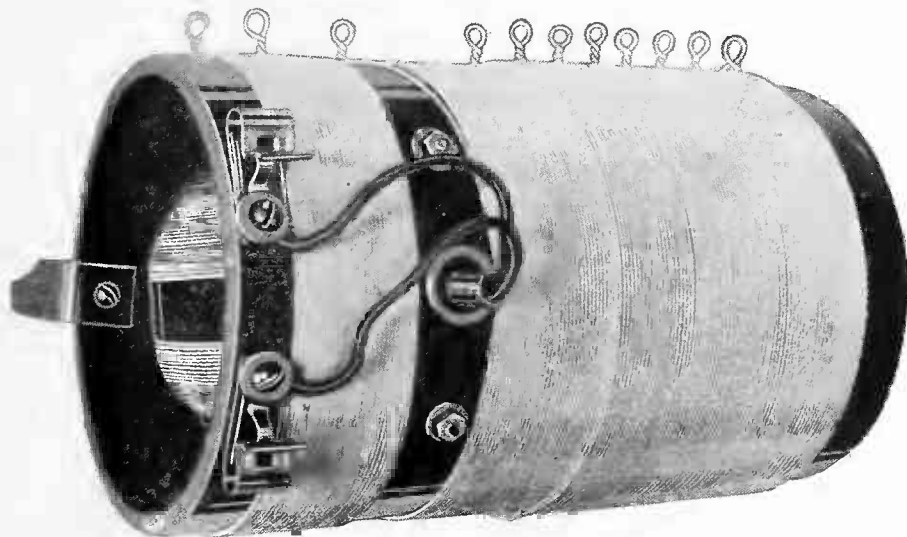

Manufacturers of

THE VOX HUMANA

The Receiver with the Living Voice

The Radio Guild

ALL RANGE COUPLER

150-3400 Meters—Bank Wound

Certificate of Excellence from The New York Mail and Radio Institute

List Price, \$9.00

DEALERS—Write for special proposition.

The Radio Guild, Inc. Phone: Longacre 10279 **256 West 34th St., New York City**

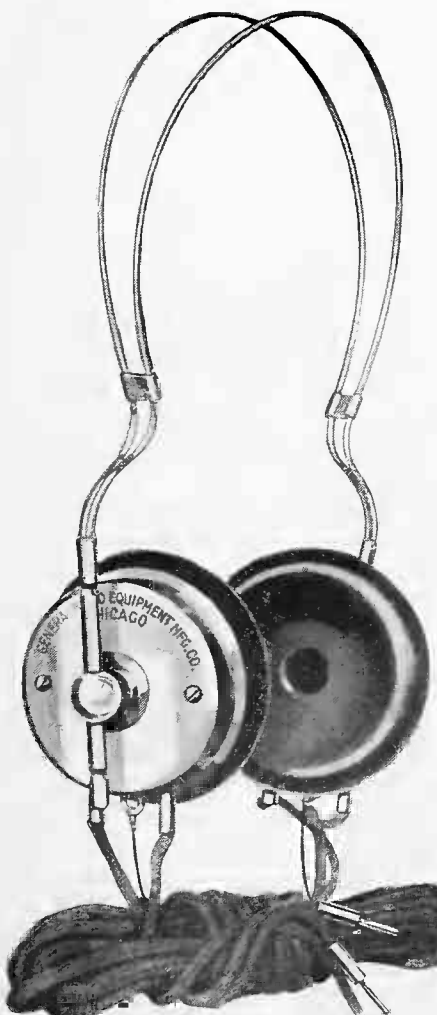

The A. C. Impedance of Our Phones Is More Closely Co-ordinated and Synchronized with All Makes of Standard Tubes Than Any Other

SPECIFICATIONS

Weight of two phones and head band—10½ oz.
 Shell—Made of finest grade of aluminum, highly polished.
 Magnets—Made of highest percentage tungsten steel.
 Magnet Coil Cores—Made of best grade of soft Norway iron.
 Magnet Wire—Best grade, enamel insulated.
 Magnet Shield—Polished nickeloid.
 Bobbin Heads—Polished nickeloid and fibre.
 Diaphragm—Special hard rolled, enameled and polished.
 Terminals—Positive connections, knurled posts imbedded in highest grade hard fibre.
 Winding—Each coil with exactly the same number of ampere turns.
 Adjustment—Precision to the thousandth of an inch.
 Testing—Each coil measured by wheatstone bridge. Each phone set matched in tone and sensitivity. Each phone radio tested.
 Head Band—Music wire nicked and polished. Feather weight (1¼ oz.). Lightest made. Proper and permanent tension. Holds phones securely, excluding all outside noise, yet with perfect comfort to wearer. No fabric covering to become soiled and unsanitary. Perfect adjustment feature of spring and ball tension holds phones at desired point, yet permits adjustment to be changed by slight pressure at proper point.
 Cord—Highest grade double conductor cord with anchor extension to remove any strain from terminal points.
 Finish—Each and every part, inside and out, is made and finished in the very best workmanship manner, pleasing to the eye as well as the ear. No detail is too small to receive the closest attention and finest workmanship.
 Results—Extra powerful, sensitive and radio perfect. No distortion, blasting or rasping of tones. Each tone reproduced with scrupulous fidelity. No sacrifice of tone quality has been made in order to obtain loudness, yet obtaining ample volume and loudness, up to the degree possible to be had without distortion. Tones come in as clear as a silver bell, the most perfect sound reproduction ever obtained. A work of highest electrical and mechanical art—meeting the most exacting demands of the best posted radio authorities.

2000 ohm Monocoil Set	\$6.00
2400 ohm Red Star Professional Set.	8.00
3200 ohm Red Star Long Distance Set.....	10.00

Attractive discount and strong cooperation for jobbers and dealers.

General Radio Equipment Mfg. Co.

1143-45 Diversey Parkway

Chicago, Ill., U. S. A.

To the Manufacturer and Dealer in Radio Equipment

We offer a specialized Engineering and Testing Service covering—

Testing and rating of equipment
 Designing of instruments and parts
 Patent search
 Plant design, production methods and cost finding

Have your radio equipment rated according to GREGG STANDARDS in preparation for the Fall business.

GREGG AND COMPANY

St. Louis, Mo.
 Newark, N. J.

Engineers

Radio Department

165 Broadway

New York City

Washington, D. C.

Los Angeles, Cal.

Mexico City, Mexico

THE MOST DESIRABLE PHONE IN THE WORLD

STANDARD MODEL 8
 RADIO TELEPHONE

HEAD SETS
 2500 Ohms

The outstanding feature of our phones is that they have laminated pole pieces, which stores up a greater magnetic force. These pole pieces are adjustable, which makes it possible to adjust each phone to receive alike, at the final test in the factory.



RETAIL PRICE
\$5.75

STANDARD MODEL 8
 RADIO TELEPHONE

HEAD SETS
 2500 Ohms

Our phones have been thoroughly tested, and we guarantee them to be equal to any phone on the market listing at \$8.00.

The adjustable polepiece feature make them adaptable for use with any stage of amplification.

NOTE.—The makers of these phones have manufactured electrical measuring instruments for the past 15 years

DISTRIBUTORS AND JOBBERS—WRITE FOR PRICES

STANDARD ELECTRIC SALES CO.

843 BROAD STREET,

NEWARK, N. J.

“Distinctive Radio Apparatus”

THE ROBBINS VARIABLE CONDENSER

43 Plate
— .001 mfd.

\$4.00

23 Plate
— .0005 mfd.

\$3.25

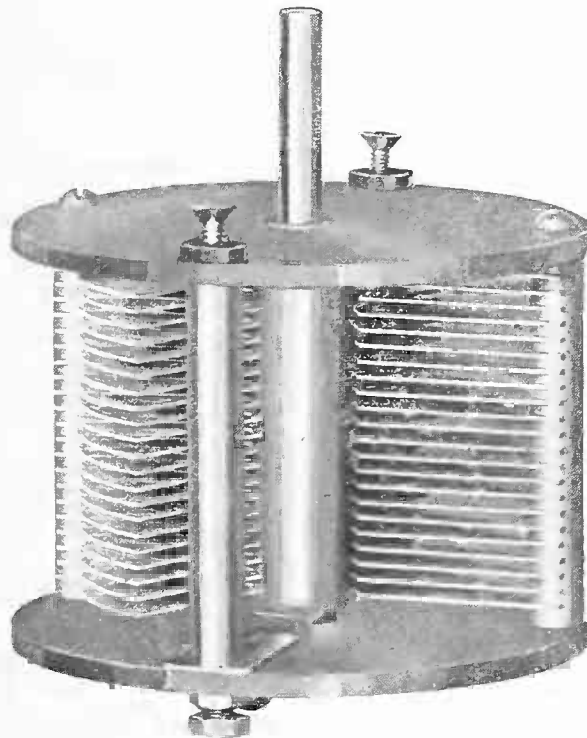

11 Plate
— .00025 mfd.

\$2.75

3 Plate
— Vernier

\$1.50

Die cast and machined throughout (not built up with washers); round bakelite ends, affording ample protection for plates; tension adjustment; mounted on metal bearings, thus preserving alignment; specially rolled aluminum plates; wonderfully well built throughout, insuring maximum sensitivity. Attractive proposition for jobbers and dealers.

Apparatus Ready for Delivery (Subject to Prior Sale)

Receiving Sets

Westinghouse RC Set.....	\$132.50
General Electric Tuner.....	50.00
General Electric Detector-Amplifier.....	75.00
Westinghouse Aeriola Sr.....	65.00
Westinghouse Aeriola Jr.....	25.00
Deforest Radiohome Set.....	36.00
Deforest Radiohome Amplifier.....	35.00

Phones

Frost 2000 ohm.....	5.00
Frost 3000 ohm.....	6.00
Murdock 2000 ohm.....	5.00
Murdock 3000 ohm.....	6.00
Brandes Superior.....	8.00
Holzer-Cabot.....	8.00
Western Electric 1004-c.....	12.00
Brandes Navy.....	14.00
Seibt.....	14.00
Western Electric.....	15.00

Herbert H. Frost Apparatus

Cord Tip Plug No. 137.....	\$1.25
Single Circuit Jack No. 133.....	.65
Closed Circuit Jack No. 134.....	.75
Double Circuit Jack No. 131.....	.90
Filament Control S.C. Jack No. 135.....	1.00
Filament Control D.C. Jack No. 136.....	1.25

Loud Speakers

Magnavox R-3.....	45.00
Magnavox R-2.....	85.00
Magnavox AC-2 Power Amplifiers.....	80.00
Magnavox AC-3 Power Amplifiers.....	110.00
Western Electric Complete.....	161.00
Westinghouse Vocorola.....	30.00

Vacuum Tubes

Radiotron or Cunningham Detectors.....	5.00
Radiotron or Cunningham Amplifiers.....	6.50
Radiotron or Cunningham 5 Watt.....	8.00

Immediate Shipments. Send for Price List and Discount Sheet

ROBBINS ELECTRIC CO.
PITTSBURGH
Established 1890

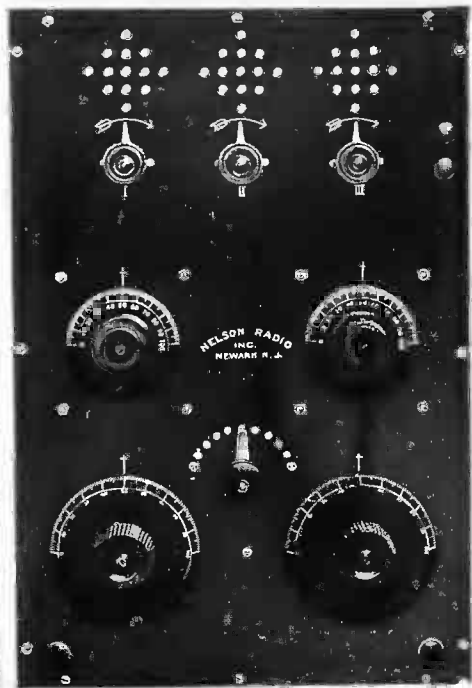

Front View

NELSON RADIOFONE RECEIVER

TYPE RS-1

Scientific Design
Excellent Workmanship
Superior Finish
Efficient Performance



List Price, - - \$100.00
Without Cabinet, - 95.00

Size, 13" x 19" x 8"

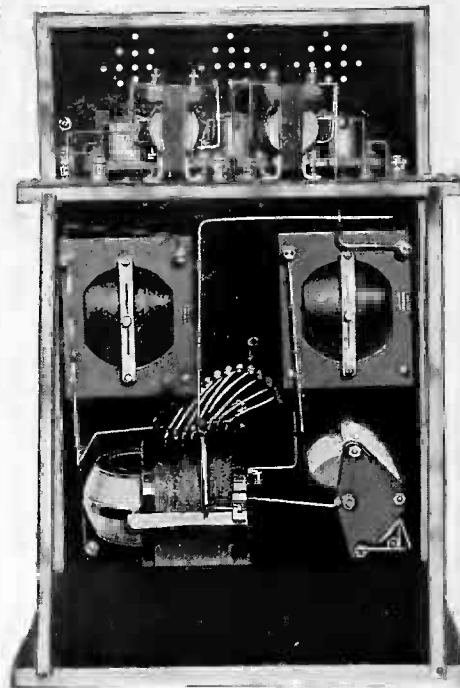

Back View

VARIO COUPLER

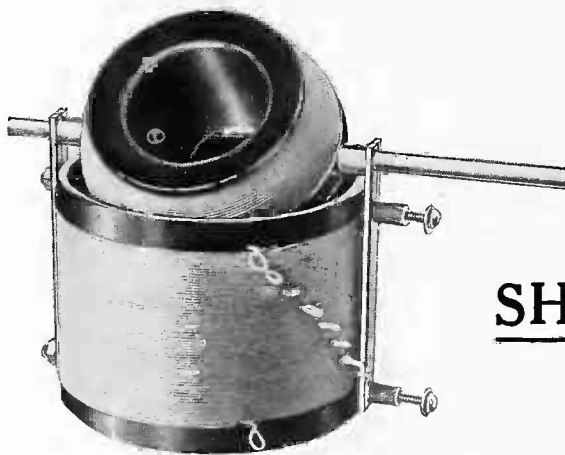

List Price, - - - \$3.50

VARIOMETER

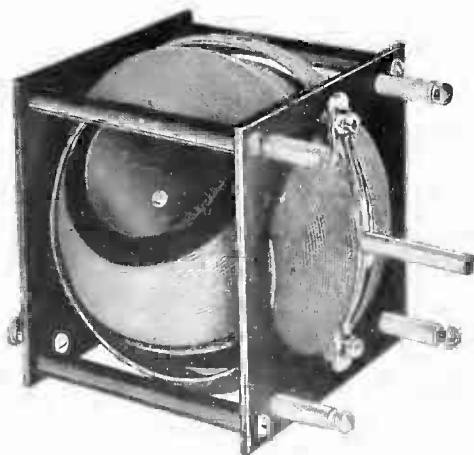

Unique in Design—Efficient in Operation

List Price, - - \$4.50

SHORT WAVE UNIT

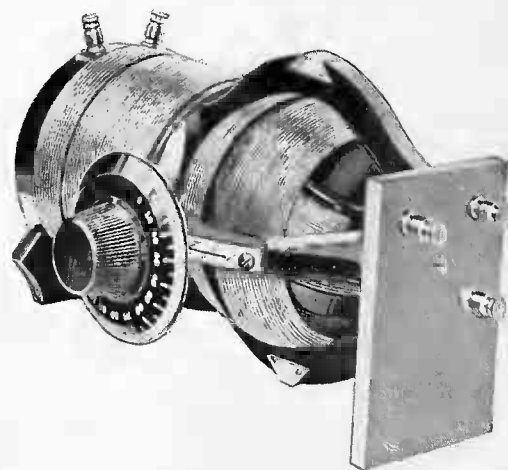

An Exclusive Utility Combination

List Price, - - - \$10.00

Dealers and Jobbers
Write for Particulars



NELSON RADIO PARTS CO.

89 ACADEMY STREET,

NEWARK, N. J.

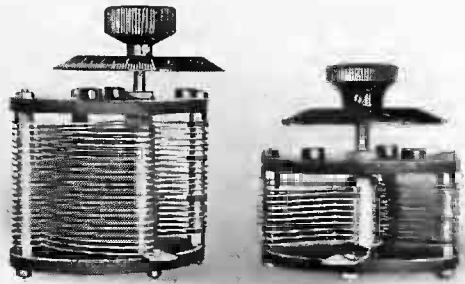

“FARADION”

Variable Condensers of Quality

Designed by J. B. Elenschneider, for over ten years Engineer for the Marconi Wireless Telegraph Co. of America.

These condensers are designed and constructed so as to embody features found only in instruments for commercial and professional use.

Already some of the manufacturers of high grade regenerative receivers have adopted our condenser for their sets.

The condensers are constructed of the highest grade material and with best workmanship. Insulating ends of high dielectric strength.

Plates of fine hard aluminum, shaped so as to give a straight line increase of wave length and minimum capacity when the condenser is in its open position.

Shafts, spacers, rods and nuts, and so forth, turned to precision—not stamped.

Each condenser fully guaranteed.

9 plates cap. .00025 M. F. list price \$3.50.

21 plates cap. .00066 M. F. list price 4.75.

41 plates cap. .0011 M. F. list price 5.75.

Knobs or dials extra.

Manufacturers, jobbers, dealers, write for discount.

Can make prompt deliveries.

RADIO LABORATORIES OF NEW JERSEY, INC., CRANFORD, N. J.

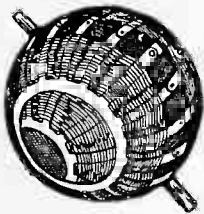

Premier

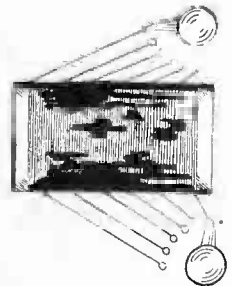
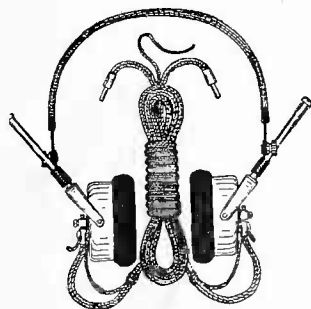
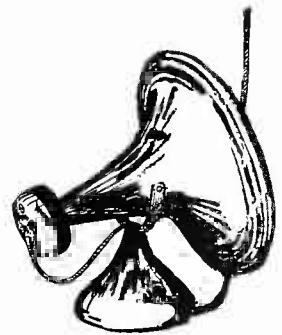

PREMIER ACCESSORY & SPECIALTY CORP.

DUPLEX LIGHT MANUFACTURING AND METAL STAMPING PHONES

2000 Ohms

\$6.50

LIST

29 CONGRESS ST., NEWARK, N. J.

WRITE FOR DISCOUNTS

3000 Ohms

\$8.00

LIST

!!! THE PREMIER RADIOVOICE !!!

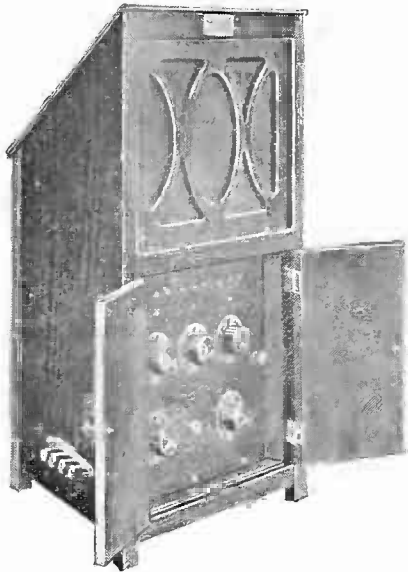

Is the first practical and commercial accomplishment of meeting the public's requirements and demand for a *Complete, Simple, Compact, Attractive and Efficient Loud Talking-Detector and 2-Stage Radio Receiver* at a Popular Price, Simple in Control—Wide in Range.

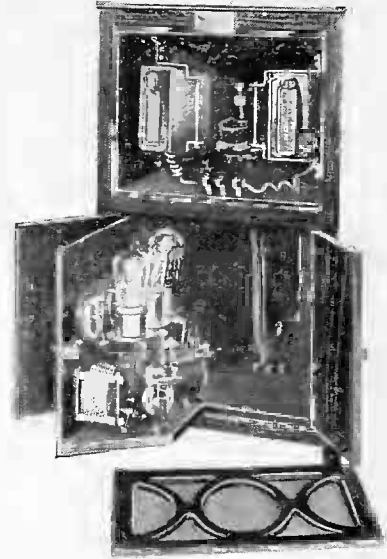

Mounted on a Bakelite Panel are Premier Built and

Tested Radio Condensers, Rheostats, V. T. Sockets, Transformers, Tuning Coils, Jacks, etc; the panel being hinged within the beautiful 5 ply Mahogany Veneer Loud Talker Cabinet, measuring 21" in height by 12" in width, weighing, completely equipped with "B" Batteries and Loud Talking Phone as shown, only 17 lbs. Can be set in a corner of the living room, on library or end table, or on a piano, blending into the richest of furnishings with equal attractiveness. Price complete, excluding only bulbs and "A" battery—\$95.00.

Where an even lower priced equipment is desired, eliminating the phone and loud talker cabinet, our Type P equipment, including "B" batteries, mounted in cabinet as shown, parts, hookup and panel being identical to that used in the Premier Radiovoice, is priced at \$55.00.

The Premier Radio Corporation is an old electrical manufacturing concern, which has turned its entire resources and equipment to production of high class radio parts and receiving sets. The Premier line is handled and is available to only the highest class of dealer, jobber or distributor, and to such is offered discounts to permit profitable merchandising. Descriptive bulletins sent on request.

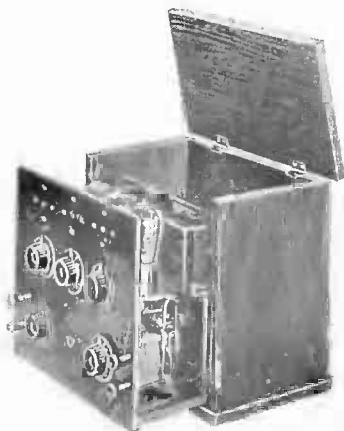

PREMIER RADIO CORPORATION

6800 BOSTWICK AVE.
DETROIT, MICH.

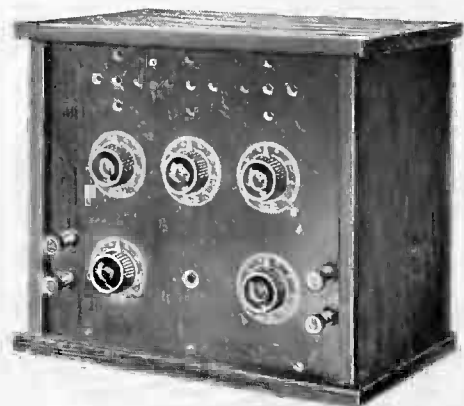

RADIO EQUIPMENT SERVICE

(Trade Name Registered)

Offers an Exceptional
Proposition to Dealers

Write for Details

Distributors of
a Complete
Line

500 FIFTH AVENUE
NEW YORK CITY

RADIO EQ SER

ANNOUNCES

RADI

Registered U. S.

A SENSATION IN THE

Receives Market Reports, Current Events, News Items, Lec

COAST T

And Flashes Your

“BROAD

With Force

ESPECIALLY ADAPTED TO INDOOR OR OUTDOOR

Name, Construction and Design

FOR STATE RIGHTS PROPOSITION

RADIO EQUIP

National Distributors

EQUIPMENT VICE

OLITE

Patent Office

WORLD OF ADVERTISING

Features and Entertainment from Famous Broadcasting Stations

COAST

ADVERTISING

CAST"

and Dignity

ADVERTISING, OR THE HOME BEAUTIFUL

Protected by Patents Pending

WRITE OR WIRE AT ONCE

MENT SERVICE

500 Fifth Ave., New York City

Gilbert Radio Apparatus

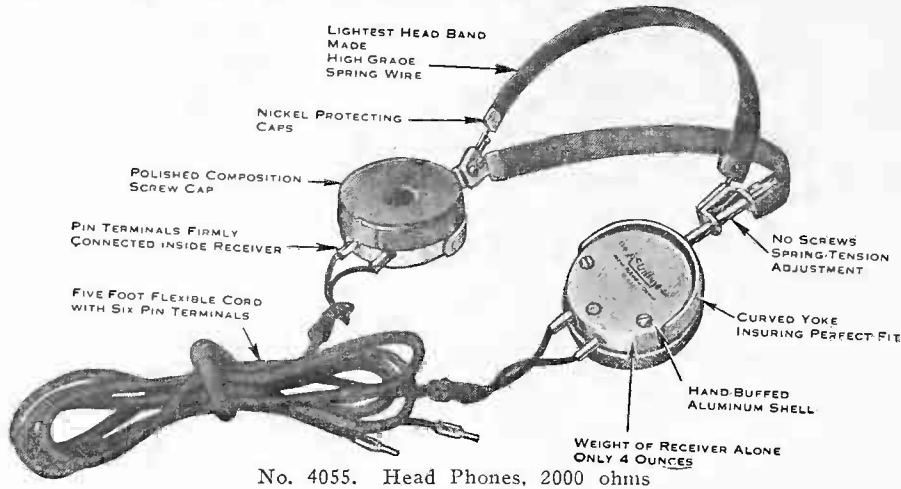

No. 4055. Head Phones, 2000 ohms



No. 4082. Variable Condenser

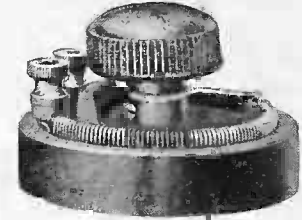

No. 4088. Rheostat

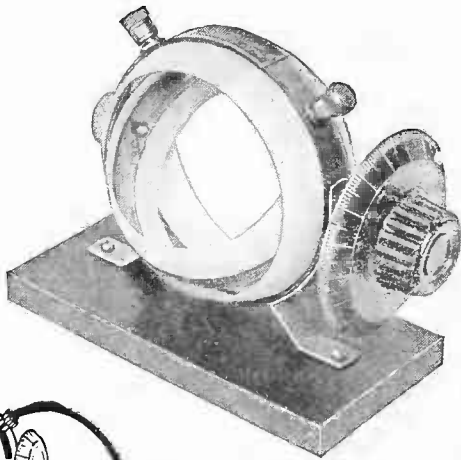

No. 4084. Variometer

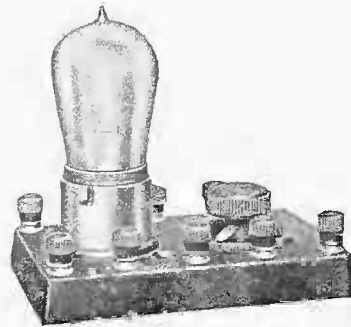

No. 4079. V. T. Control

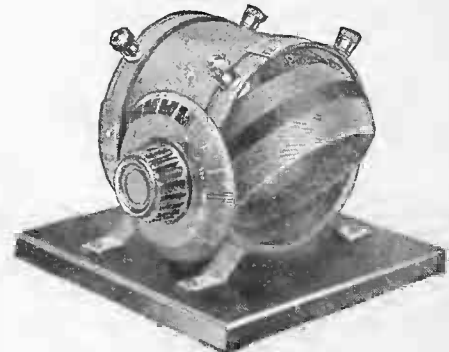

No. 4085. Variocoupler



Quality Radio Parts at Popular Prices

Gilbert Radio Parts represent the very latest developments in the science Radio. They are scientifically constructed instruments, carefully and sturdily built, and so designed that even the novice can build a Radio Receiver second to none. All of the most necessary and advanced parts are included in the Gilbert Line, some of which are illustrated above.

In keeping with the usual Gilbert Policy, they are backed by a sales compelling advertising campaign—popular priced and show a splendid margin of profit. Be ready for the big radio demand this Fall. Put in your stock the line that means rapid turnover and big profits.

Write for Catalog No. 54, just off the press

THE A. C. GILBERT COMPANY

DEPT. C

NEW HAVEN, CONN.

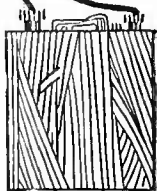

THE RADIO DEALER

The Radio Trade Journal

For The Radio Retailer

CONTENTS AUGUST, 1922

SPECIAL ARTICLES

Armstrong Circuit Pointers.....	By S. E. Tupper	99
"Ask Our Service Bureau".....	By B. B. Stern	68
Dealer Should Avoid Fear Advertising.....	By James Weir	36
Few Pointers in This New Business.....	By Adrian Good	32
Have You Ideas?.....	By Zoltan H. Polachek	23
Increased Interest to Be on Sounder Basis.....	By Charles H. Lehman	26
Maker of Auto Parts Has Remarkable Rise in Radio.....	By R. F. Stayman	27
Making Money in the Radio Business.....	By H. G. Cisin	27
Many Join National Association.....	By Bernard J. Farrell	21
Many at Chicago Show.....	By L. A. Nixon	34
New Broadcasting Stations.....		62
Much Misunderstood Crystal Detector.....	By Claude Cathcart Levin	29
National Trade Survey of the Radio Industry.....	By John R. Hall	32
Noisy "B" Batteries and Why.....	By Walter B. Schulte	24
Out with the Fakers in the Radio Industry.....	By H. M. Konwiser	22
Radio Guild Makes "Set with Human Voice".....	By J. McKerchar	93
Radiolite, a New Phase in Radio.....	By Thomas J. Ryan	82
Retailers Should Really Advertise Now.....	By Eugene J. Scanlon	27
Summer Slump Benefits Radio Industry.....	By Alexander Eisemann	23
Trade-Mark Changes.....	By Chauncey P. Carter	59
Ways of Developing with Radio Industry.....	By William Guild	25

DEPARTMENTS

Advertising for Retail Dealer.....		39
Book Review.....	By Bernard J. Farrell	69
Editorial.....		30, 31
Trade-Mark Department.....	By Chauncey P. Carter	57
Milwaukee.....		58
Philadelphia Pointers.....	By W. B. Wilkinson	73
Radio Stocks.....	By Frank Stanton	71
What the Manufacturers Are Doing.....		56

THE RADIO DEALER, THE RADIO TRADE JOURNAL, published monthly at 1133 Broadway, New York, N. Y., by THE RADIO DEALER COMPANY, in the interest of dealers in Radio Supplies. HARRY M. KONWISER, Publisher; LAURENCE A. NIXON, Managing Editor; N. B. ZIMMERMAN, Editor; A. L. KONWISER, B.S., Technical Editor; Bernard J. Farrell and Eugene J. Scanlon, Associates; Jos. J. Ollendorf, Circulation Manager; John R. Hall, Research Manager.

REPRESENTATIVES IN THE TRADE: Elmer W. Moore, John R. Hall, H. E. Bennett, Wm. B. Wilkinson, Jr., J. M. Casper, J. A. Doucet, H. L. Krenz, M. A. Clark, C. L. Geesey, S. A. Frank, C. M. Minier, M. Jay Klein.

PUBLICATION OFFICE
1133 Broadway, New York, N. Y.
Telephone Watkins 8926-8927

SOUTHERN STATES
730 Gravier Street, New Orleans, La.

PITTSBURGH
Suite 570, Union Arcade, Pittsburgh, Penna.

PACIFIC COAST
Suite 910, 456 Spring Street, Los Angeles, Calif.

CENTRAL STATES
35 South Dearborn Street, Chicago, Ill.
Telephone Dearborn 4053

NEW JERSEY
845 Broad Street, Newark, N. J.
Telephone Market 4659

Advertising Rates and detailed statement of circulation and other information for advertisers furnished on application.
Circulation restricted to manufacturers, jobbers and retailers in wireless equipment. Subscription in the United States, one dollar the year, payable invariably in advance. Subscription in foreign countries, two dollars the year, payable invariably in advance.

Radio Equipment of the Highest Standard at Prices Made to Stimulate Summer Sales

EVERYTHING NEEDED TO STOCK YOUR STORE

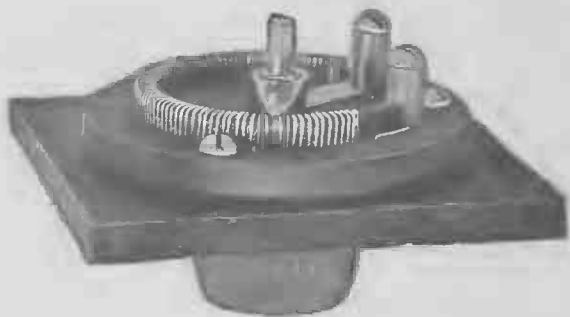

DRISCO RHEOSTAT

List.....80 Cents
The only rheostat on the market with resistor strip inserted *ENTIRELY* through base making cement or glue unnecessary and contact perfect at all times.

Other Specialties:

RADIOMETER
VARIOCOUPERS
HEADSETS
VERNIER RHEOSTATS
PHONE CONDENSERS
GRID CONDENSERS
SOCKETS
COMPLETE SETS

POTENTIOMETER
VARIOMETERS
DIALS
PLUGS
TUBES
SWITCH LEVERS
SPAGHETTI
ETC.

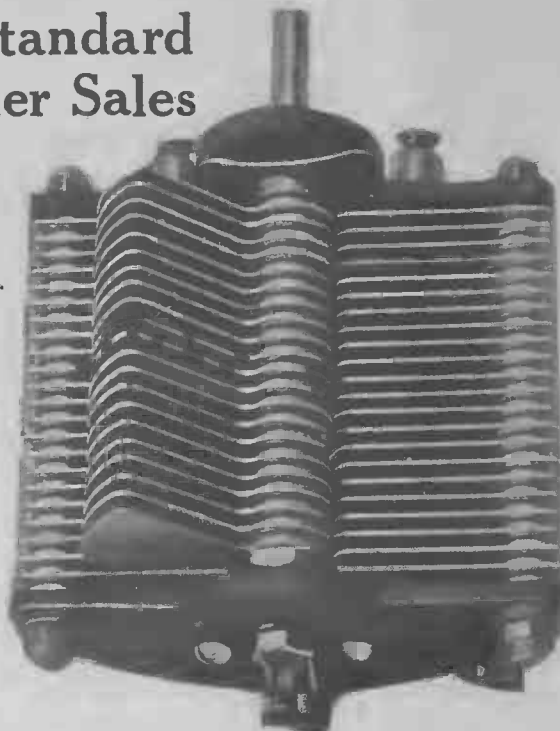

43 PLATE CONDENSER

List.....\$3.75
Equipped with Fahnestock Clips and wire ring washers giving perfect alignment between plates. Nickel finish throughout. Packed in individual boxes and furnished with stencil to aid mounting.

HAROLD M. SCHWAB, Inc.

Sole Distributor of Drisco Products

Write for Descriptive Catalogue

419 WEST 42nd STREET, NEW YORK CITY

Back Again!!

THE RADIO TELEGRAPHER

Established in 1917

Official Organ United Telegraphers' Association
The Only Paper for the Professional Radio Operator
Once Each Month. One Dollar the Year

Advertising Rates Upon Application

Published by

HARRY M. KONWISER

Publisher, The Radio Dealer

1133 Broadway

New York City